



KOMPERDELL

www.komperdell.com

WORKBOOK

2023/24



100% MADE IN AUSTRIA

AT KOMPERDELL YOU KNOW WHERE IT IS MADE AND WHO IS RESPONSIBLE FOR IT

From the first idea to serial production, we are one stop manufacturer in the heart of Austria. For more than 100 years we are an innovative pioneer providing outstanding quality, unique service and honest sustainability.



WE ARE INNOVATOR AND MANUFACTURER

We are one of the few brands who are still manufacturer. Apart from our own brand we develop, design and manufacture individual poles for more than 40 leading ski and retail brands.

FAST AND FLEXIBLE INDIVIDUAL PRODUCTION

Due to our regional production we are able to produce fast and flexible with fewer logistics. Our large stock of raw materials and moreover the passion of our employees enables us to shorten lead times to an absolute minimum.

HONEST SUSTAINABILITY

We run our business with an honest awareness of our environment without the need of any „green“ certificates. Due to our production in Mondsee/Austria we have to fulfil highest environmental standards as we produce where we live and where others enjoy their vacation.

UNIQUE QUALITY AND SERVICE

Our aim is to produce highest quality products and offer a unique 3-year-free repair service to extend our product's lifecycle.



 **HENRIK KRISTOFFERSEN**
 WORLD CHAMPION GIANT SLALOM
 3-TIME SLALOM WORLD CUP GLOBE WINNER
 GIANT SLALOM WORLD CUP GLOBE WINNER
 2 OLYMPIC MEDALS

Henrik Kristoffersen

RACING WORLD CUP



MARCO SCHWARZ
 WORLD CHAMPION IN COMBINATION



Marco Schwarz

© GEPA-PICTURES



© GEPA-PICTURES



CORNELIA HÜTTER
 WORLD CUP WINNER



© GEPA-PICTURES

CHAMPION'S CHOICE

TRUSTED BY MORE THAN 200 ATHLETES

We are collaborating with the best athletes to always be one step ahead. Resulting in the most successful racing brand in history.

SOLID SCREW JOINT
for extra tight fit and no twisting of the punch protection

PUNCH PROTECTION
made of highly resistant thermoplastic resin, absorbs hard impacts

SHRINKING TUBE
reinforcing of the shaft

STRAP SECURING
prevents tearing out of the strap

WORLD CUP EQUIPMENT
extremely stiff materials and precise manufacturing for highest demands

CLICK-IN SKICROSS STRAP
keeping the hands free at the starting gate

CARBON TUBE WITH TI CORE
for maximum performance

NATIONALTEAM CARBON SLALOM 12,3

Sizes: 100 - 140 cm (in 5 cm steps)

Features:

- * technical grip with rubber & punch cover World-Cup style
- * race strap
- * carbon, Ø 12,3 mm
- * mini race basket
- * flex carbide RACE tip

art. # 147 32 51-48

NATIONALTEAM CARBON GS 12,3

Sizes: 105 - 140 cm (in 5 cm steps)

Features:

- * race grip Duplo
- * race strap
- * carbon, Ø 12,3 mm
- * downhill basket
- * flex carbide RACE tip

art. # 147 32 54-48

NATIONALTEAM CARBON SKICROSS TI CORE

Sizes: 105 - 140 cm (in 5 cm steps)

Features:

- * 2-K touring click-in grip
- * click-in skicross strap
- * carbon, Ø 16 mm TI core bent
- * mini race basket
- * flex carbide RACE tip

art. # 148 10 58-48

BASKETS & TIPS
Fixed with special glue for extra strong holding force

RACING WORLD CUP



SOFIA GOGGIA
OLYMPIC CHAMPION IN DOWNHILL
3-TIMES WORLD CUP GLOBE WINNER DOWNHILL

© GEPA-PICTURES



RACE GRIP
offers perfect grip and
a secure feeling

WORLD CUP

NATIONALTEAM CARBON GS BENT

Sizes: 115 - 140 cm
(in 5 cm steps)

Features:

- * race grip Duplo
- * race strap
- * carbon, Ø 16/10 mm, bent
- * downhill basket
- * flex carbide RACE tip

art. # 148 10 54-48



BENT CARBON
aerodynamic bent
for maximum speed

WORLD CUP

NATIONALTEAM CARBON SUPER-G

Sizes: 120 - 140 cm
(in 5 cm steps)

Features:

- * race grip Duplo
- * race strap
- * carbon, Ø 16/10 mm, bent
- * downhill basket
- * flex carbide RACE tip

art. # 148 10 52-48



WORLD CUP

NATIONALTEAM CARBON DOWNHILL

Sizes: 120 - 140 cm
(in 5 cm steps)

Features:

- * race grip Duplo
- * race strap
- * carbon, Ø 16/10 mm, bent
- * downhill basket
- * flex carbide RACE tip

art. # 148 10 53-48

RACING CARBON



PETRA VLHOVA
GIANT SLALOM WORLD CHAMPION
OLYMPIC CHAMPION IN SLALOM
OVERALL WORLD CUP WINNER
2-TIMES SLALOM WORLD CUP GLOBE WINNER

© GEPA-PICTURES



© GEPA-PICTURES



KIRA WEIDLE
5 WORLD CUP PODIUMS
WM SILVER MEDAL

HIGH PERFORMANCE CARBON

We develop our own carbon tubes. Top-quality japanese carbon fibers in combination with our unique production technique and resins result in top quality carbon poles with breaking points up to 200 kg's.



NATIONALTEAM CARBON

Sizes: 110-135 cm
(in 5 cm steps)

Features:

- * race grip rubber
- * race strap
- * carbon, Ø 13/9 mm
- * mini race basket
- * tungsten/carbide flex tip

art. # 146 42 01-48

JUNIOR-EDITION

The perfect racing pole made of extra light carbon for tomorrow's winner!



NATIONALTEAM CARBON JUNIOR

Sizes: 85-115 cm
(in 5 cm steps)

Features:

- * Kids Race rubber grip
- * race strap
- * carbon, Ø 13/9 mm
- * mini race basket
- * tungsten/carbide flex tip

art. # 146 42 02-48

RACING ALUMINUM



WORLD CUP *****

NATIONALTEAM ALU SLALOM 19 MM

Lengths: 100 - 135 cm
(in 5 cm steps)

- Features:**
- * technical grip with rubber & punch cover World-Cup style
 - * race strap
 - * aluminum 7075-T6, Ø 19 mm
 - * mini race basket
 - * tungsten/carbide flex tip

art. # 144 42 51-48



WORLD CUP *****

NATIONALTEAM ALU SUPER-G 19 MM

Sizes: 100 - 135 cm
(in 5 cm steps)

- Features:**
- * race grip Duplo
 - * race strap
 - * aluminum 7075-T6, Ø 19 mm bent
 - * downhill basket
 - * tungsten/carbide flex tip

art. # 144 42 50-48



WORLD CUP *****

NATIONALTEAM PROFI 19 MM

Lengths: 100 - 135 cm
(in 5 cm steps)

- Features:**
- * race rubber grip
 - * race strap
 - * aluminum 7075-T6, Ø 19 mm
 - * mini race basket
 - * tungsten/carbide flex tip

art. # 144 42 01-48



LUCAS BRAATHEN
WORLD CUP WINNER

© GEPA-PICTURES



NATIONALTEAM SUPER-G 18 MM

Sizes: 110 - 135 cm
(in 5 cm steps)

- Features:**
- * rubber race grip
 - * race strap
 - * aluminum 7075-T6, Ø 18 mm
 - * downhill basket
 - * tungsten/carbide flex tip

art. # 134 42 02-48



NATIONALTEAM 18 MM

Sizes: 110 - 135 cm
(in 5 cm steps)

- Features:**
- * rubber race grip
 - * race strap
 - * aluminum 7075-T6, Ø 18 mm
 - * mini race basket
 - * tungsten/carbide flex tip

art. # 134 42 01-48



NATIONALTEAM SUPER-G JUNIOR

Sizes: 85 - 115 cm
(in 5 cm steps)

- Features:**
- * Kids race grip (length 85 - 95 cm) / Junior race grip (length 100 - 115 cm)
 - * race strap
 - * Alu 7075-T6, Ø 16 mm
 - * downhill basket
 - * tungsten/carbide flex tip

art. # 224 42 02-48



length 85 - 95 cm
Kids Race grip

length 100 - 115 cm
Junior Race grip

JUNIOR-EDITION

Nationalteam poles made of extremely strong aluminum for true Worldcup feeling!



NATIONALTEAM JUNIOR

Sizes: 85 - 115 cm
(in 5 cm steps)

- Features:**
- * Kids race grip (length 85 - 95 cm) / Junior race grip (length 100 - 115 cm)
 - * race strap
 - * aluminum 7075-T6, Ø 16 mm
 - * mini race basket
 - * tungsten/carbide flex tip

art. # 224 42 01-48

PROTECTION CARBON



**INCLUSIVE
TRANSPORT BAG**

LEADING EDGE
ensures that the slalom poles
slide off to the outside



CUSTOMIZED FIT
provides perfect
close fitting

REINFORCED SURFACE
provides perfect protection
for the full length of the shin



**FLEXIBLE
OUTER EDGE**
suitable for any
leg or calve size



**INDIVIDUALLY
ADAPTABLE**



**SHORTEN TO
INDIVIDUAL LENGTH**
close fitting
with the boot

CARBON SHINGUARD WORLD CUP

art. # 6535-48



**REINFORCED MATERIAL
IN THE CENTER**
perfect protection from
hitting the slalom poles

**FLEXIBLE
OUTER EDGE**
to adjust to
every shape



**INDIVIDUALLY
ADAPTABLE**



SCREWS AND STRAPS
for your optimal
position and best hold

CARBON ELBOW GUARD WORLD CUP

art. # 6537-48

PUNCH PROTECTION WORLD CUP

■ art. # 156-48
■ art. # 156-02

PUNCH PROTECTION PRO

■ art. # 158-48
■ art. # 158-02

PUNCH PROTECTION BIG

■ art. # 153-48

PUNCH PROTECTION SMALL

■ art. # 152-48

RACING PROTECTION



SEAMS AT THE OUTSIDE
no irritating seams
on the fingertips



NON-SLIP PALM
for best grip

extremely warm &
genuine leather



**EXPANDED
KNUCKLE
PROTECTION**
made of Carbon



TOUGH-STUFF MATERIAL
extremely abrasion
resistant – also used
in motorcycling

**PADDING IN
ARMADILLO PRINCIPLE**
flexible punch protection

JUNIOR VERSION
for young shooting stars

RACING GLOVE

Sizes: XS - XL

Features:

- * real leather
- * special thermal insulation
- * knuckle protection made of carbon (only Adult)
- * shock absorbing foam at finger, thumb and back of the hand

art. # 6501-02 adult

art. # 6620-02 junior



RACING LOBSTER

Sizes: XS - XL

Features:

- * real leather
- * special thermal insulation
- * knuckle protection made of carbon (only Adult)
- * shock absorbing foam at finger, thumb and back of the hand

art. # 6502-02 adult

art. # 6621-02 junior

IMPACT PROTECTION
protector foam for real
impact protection and
ideal fitting



UPDATED SHAPE
for best fit on the
elbow

NEW

ELBOW PROTECTION WORLD CUP

art. # 6623-213 adult

art. # 6625-213 junior

IMPACT PROTECTION
protector foam for real
impact protection and
ideal fitting



**SHORTEN TO
INDIVIDUAL LENGTH**
tight fitting for
every ski boot



NEW

SHIN GUARD PROFI WORLD CUP

Features:

- * individual fit

art. # 6622-213 adult

art. # 6624-213 junior



© GEPA-PICTURES

VINCENT KRIECHMAYR
WORLD CHAMPION DOWNHILL
WORLD CHAMPION SUPER-G
WORLD CUP GLOBE WINNER SUPER-G



SLALOM RACE SUIT

Sizes: Adult: XXS - XXL
Junior: 116 - 152

Features:

- * integrated protectors at upper arms, forearms, shoulders, hips, tailbone thigh & knee
- * special racing material
- * elastic and breathable
- * extra warm due to the thermo fleece lining
- * preshaped cut - adapted to the racing position
- * thumb-loops
- * 2-way front zip
- * perfect combination with FIS Approved Race Pack

art. # 6614-01 adult
art. # 6615-01 junior



ALSO FOR YOUNG RIDERS

SIZE CHART FOR JUNIORS

size	unisex	age
116	XS	6 years
128	S	8 years
140	M	10 years
152	L	12 years

4-WAY STRETCH MATERIAL
for highest resistance and flexibility



ELASTIC



PROTECTION OF TAILBONE

FULL PROTECTOR RACE SUIT

Sizes: Adult: XXS - XXL
Junior: 116 - 152

Features:

- * with integrated protector at the back
- * special racing material
- * elastic and breathable
- * extra warm due to the thermo fleece lining
- * integrated protectors at upper arms, forearms, shoulders, hips, tailbone, thigh & knee
- * preshaped cut - adapted to the racing position
- * thumb-loops
- * 2-way front zip

art. # 6612-01 adult
art. # 6613-01 junior



BACK PROTECTION
from the 7th cervical
to the tailbone

EXTRA WARM
extra warm due to thermo fleece lining

RACING PROTECTION



NEW! 25% LIGHTER AND EVEN MORE FLEXIBLE

DETACHABLE CHEST STRAP

MEETS FIS REGULATIONS



RACE PACK

Sizes: Adult: XXS - XL
Junior: 116 - 152

Features:

- * multilayer Cross Flex back-protector made of adaptive dual-density foam, EN-approved 1621-2
- * conforms to FIS regulations
- * anatomic shaped back part
- * new preshaped strap system for best fit - shoulder it like a backpack
- * protector insert visible - part of the design concept
- * ultimate freedom of movement
- * slim kidney belt for perfect fit, adjustable with velcro and plush

art. # 6618-208 adult
art. # 6619-208 junior



BACK PROTECTION

multilayer Cross 6.0 protector for perfect protection

FULL PROTECTOR SLALOM SHIRT LONG

Sizes: Adult: XS - XL
Junior: 116 - 152

Features:

- * perfect breathability, comfortable to wear
- * multilayer Cross 6.0 back-protector, made of adaptive dual-density foam, EN-approved 1621-2
- * perfect protection of back, shoulders, shoulderblades & arms

art. # 6301-208 Adult
art. # 6302-208 Junior



PROTECTOR SLALOM SHIRT

Sizes: Adult: XS - XL
Junior: 116 - 152

Features:

- * perfect breathability, comfortable to wear
- * body-shape cut
- * multilayer protectors made of dual-density foam
- * perfect protection of shoulders, shoulderblades and arms
- * specially shaped back for perfect combination with the Fis approved Race Pack

art. # 6283-02 Adult
art. # 6284-02 Junior



SEVERAL COMPARTMENTS
with partitions for goggles, helmet and punch guards



WATERPROOF BOTTOM-CONSTRUCTION

SIDE POCKETS
to store ski-boots or other accessories

NATIONALTEAM SKI BOOT BAG

Features:

- * Ski-boots to be stored either in the main compartment or in the side pockets (dry compartment)
- * partitions in the main compartment (e.g. for helmet, goggles, punch guards)
- * adjustable and padded shoulder-straps, straps for chest and waist
- * back-straps can be stowed away
- * waterproof bottom construction
- * measurements 600x500x350 mm
- * total volume 72 l

art. # 6503-208



BACK-STRAP SYSTEM
can be stowed away

NATIONALTEAM EXPANDABLE POLE & SKI BAG

Features:

- * capacity for 4 pair of skis plus poles
- * integrated straps with non-slip fixing
- * tear-proof and robust
- * total length 150 cm / 109.2 liters
- * expandable on both ends for 35 cm to a total of 220 cm / 160.16 l

art. # 6414-02



total length 220cm expanded on both ends

expandable on both ends up to 35 cm total length of 220 cm possible

total length 150 cm compact

+ 35 CM

personalization is optional

NATIONALTEAM EXPANDABLE POLE & SKI BAG WITH WHEELS

Features:

- * capacity for 4 pair of skis plus poles
- * integrated straps with non-slip fixing
- * reinforced and padded bottom
- * integrated wheels
- * carry-system can be adjusted to the individual center of gravity
- * total length 150 cm / 109.2 liters
- * expandable in length for 70 cm to 220 cm / 60.16 liters
- * packed size 75 cm

art. # 6500-02



total length 220 cm one side adjustable

carry-system can be adjusted to the individual center of gravity

2 straps on the inside to secure the skis

total length 150 cm compact

wheels for easy transport

packed size 75x28cm

ALPINE CHAMPION



CARBON CHAMPION GREEN HENRIK

- Sizes:** 110 - 135 cm
(in 5 cm steps)
- Weight:** 201 grams (125 cm)
- Features:**
- * race grip rubber
 - * Comfort Strap
 - * carbon, Ø 13 mm
 - * mini race basket
 - * flex steel tip

art. # 146 23 28-10



CARBON CHAMPION PINK ALICE

- Sizes:** 110 - 135 cm
(in 5 cm steps)
- Weight:** 201 grams (125 cm)
- Features:**
- * race grip rubber
 - * Comfort Strap
 - * carbon, Ø 13 mm
 - * mini race basket
 - * flex steel tip

art. # 146 23 29-10



CHAMPION GREEN HENRIK

- Sizes:** 110 - 135 cm
(in 5 cm steps)
- Weight:** 212 grams (125 cm)
- Features:**
- * race grip rubber
 - * Comfort Strap
 - * aluminum 5083, Ø 18 mm
 - * mini race basket
 - * steel tip

art. # 132 22 36-02



CHAMPION PINK ALICE

- Sizes:** 110 - 135 cm
(in 5 cm steps)
- Weight:** 212 grams (125 cm)
- Features:**
- * race grip rubber
 - * Comfort Strap
 - * aluminum 5083, Ø 18 mm
 - * mini race basket
 - * steel tip

art. # 132 22 37-02

ALPINE BAMBOO

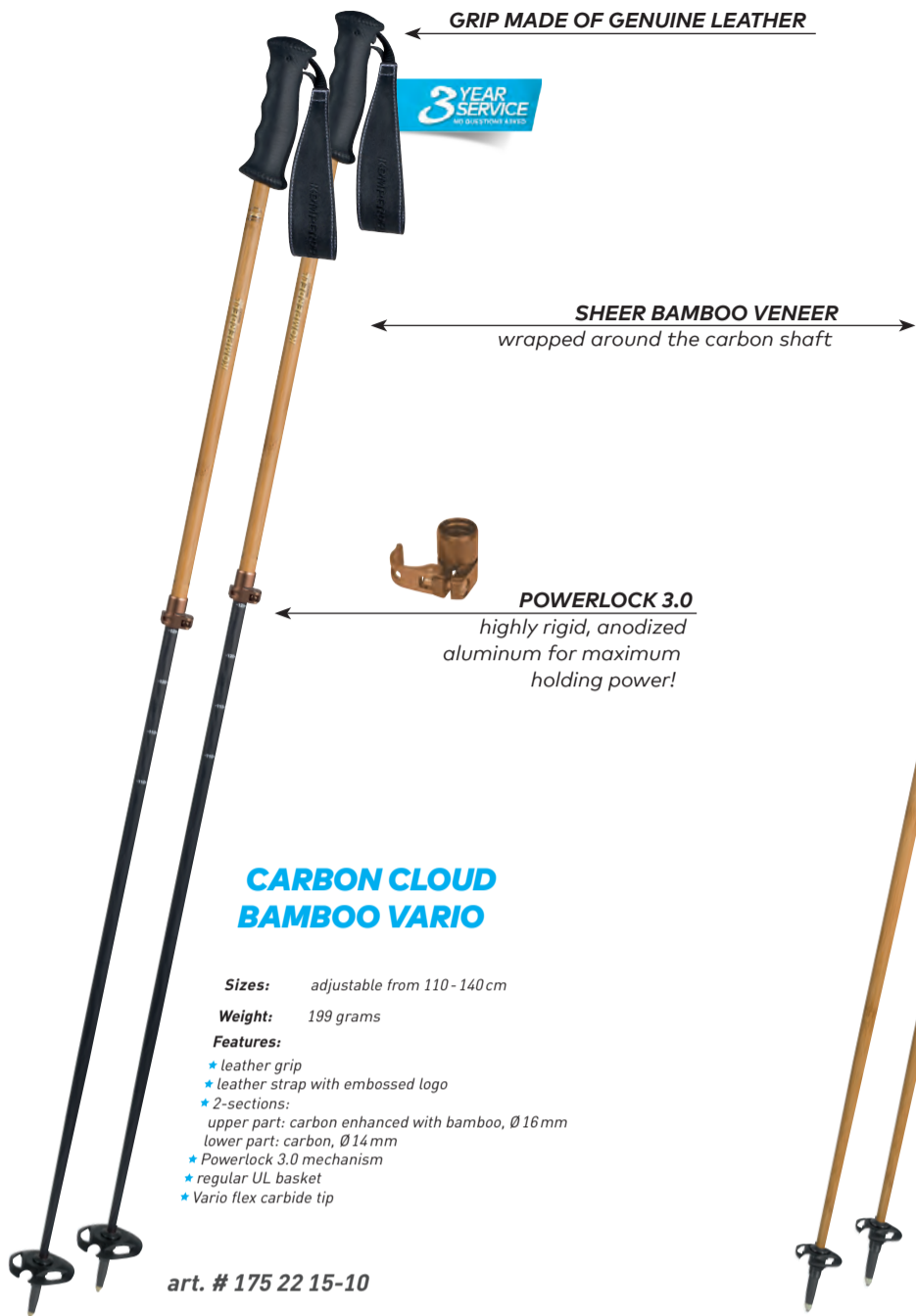

CARBON CLOUD BAMBOO VARIO

Sizes: adjustable from 110 - 140 cm

Weight: 199 grams

Features:

- * leather grip
- * leather strap with embossed logo
- * 2-sections:
 - upper part: carbon enhanced with bamboo, Ø 16 mm
 - lower part: carbon, Ø 14 mm
- * Powerlock 3.0 mechanism
- * regular UL basket
- * Vario flex carbide tip

art. # 175 22 15-10

CARBON CLOUD BAMBOO

Sizes: 110 - 135 cm (in 5 cm steps)

Weight: 163 grams (125 cm)

Features:

- * leather grip
- * leather strap with embossed logo
- * carbon featherlight, Ø 16 mm
- * enhanced with bamboo
- * Mini UL basket
- * Vario flex carbide tip

art. # 148 22 20-10



CARBON CLOUD DARK KNIGHT

Sizes: 110 - 135 cm (in 5 cm steps)

Weight: 134 grams (125 cm)

Features:

- * Foam Pistol grip
- * Air Padded Strap
- * carbon, Ø 16 mm cloud
- * Mini UL basket
- * Vario flex carbide tip

art. # 148 23 42-10



CARBON CLOUD WHITE KNIGHT

Sizes: 110 - 135 cm (in 5 cm steps)

Weight: 134 grams (125 cm)

Features:

- * Foam Pistol grip
- * Air Padded Strap
- * carbon, Ø 16 mm cloud
- * Mini UL basket
- * Vario flex carbide tip

art. # 148 23 43-55

ALPINE CLOUD

OUR MOST LIGHTWEIGHT POLE ONLY 134 GRAMS



ALPINE BOOSTER



BOOSTER SPEED CARBON SERIES

Sizes: 110 - 135 cm
(in 5 cm steps)

Weight: 194 grams (125 cm)

Features:

- * 2K Pistol grip
- * comfort strap
- * Carbon, Ø 13 mm
- * mini UL basket
- * flex steel tip

- art. # 146 23 43-10 black-red
- art. # 146 23 44-10 black-yellow
- art. # 146 23 47-09 white-silver
- art. # 146 23 46-10 black-grey



BOOSTER SPEED ALUMINUM SERIES

Sizes: 110 - 135 cm
(in 5 cm steps)

Weight: 199 grams (125 cm)

Features:

- * 2K Pistol grip
- * comfort strap
- * Aluminum, Ø 16 mm
- * mini UL basket
- * steel tip

- art. # 138 23 88-02 black-yellow
- art. # 138 23 95-09 white-silver
- art. # 138 23 90-02 black-red
- art. # 138 23 92-03 red-black
- art. # 138 23 96-02 black-grey



ALPINE BLAZER



BLAZER BLACK/WHITE

Sizes: 110 - 135 cm
(in 5 cm steps)

Weight: 230 grams (125 cm)

Features:

- * race grip PU soft
- * system strap
- * aluminum 5086, Ø 18 mm
- * mini UL basket
- * steel tip

■ art. # 132 22 45-02 black
□ art. # 132 22 46-01 white



BLAZER

Sizes: 110 - 135 cm
(in 5 cm steps)

Weight: 230 grams (125 cm)

Features:

- * racegrip PE
- * standard strap
- * aluminum 5086, Ø 18 mm
- * mini UL basket
- * steel tip

art. # 132 11 06-10



FUNNEL
TO FILL

ALPINE SCHNAPSPOLE

Sizes: 110 - 135 cm
(in 5 cm steps)

Weight: 327 grams (125 cm)

Features:

- * inner tube for Schnaps including funnel
- * volume: approx. 0,2l /pole
- * PE-grip with inner tube
- * standard strap
- * aluminum 7075, Ø 19 mm
- * mini UL basket
- * steel tip

art. # 144 93 03-02



ALPINE JUNIOR



3 YEAR SERVICE
ON BATHING EDGE

SABRE SMASH

Sizes: adjustable from 80 - 105 cm

Features:

- * Sabre grip junior
- * Twist Lock system
- * 2-sections: aluminum 7075, Ø 16/14 mm
- * racing basket vario
- * steel tip

art. # 164 32 04-48

TWISTLOCK MECHANISM
Due to the easy mechanism the length can be adjusted from 80 - 105 cm individually to your child

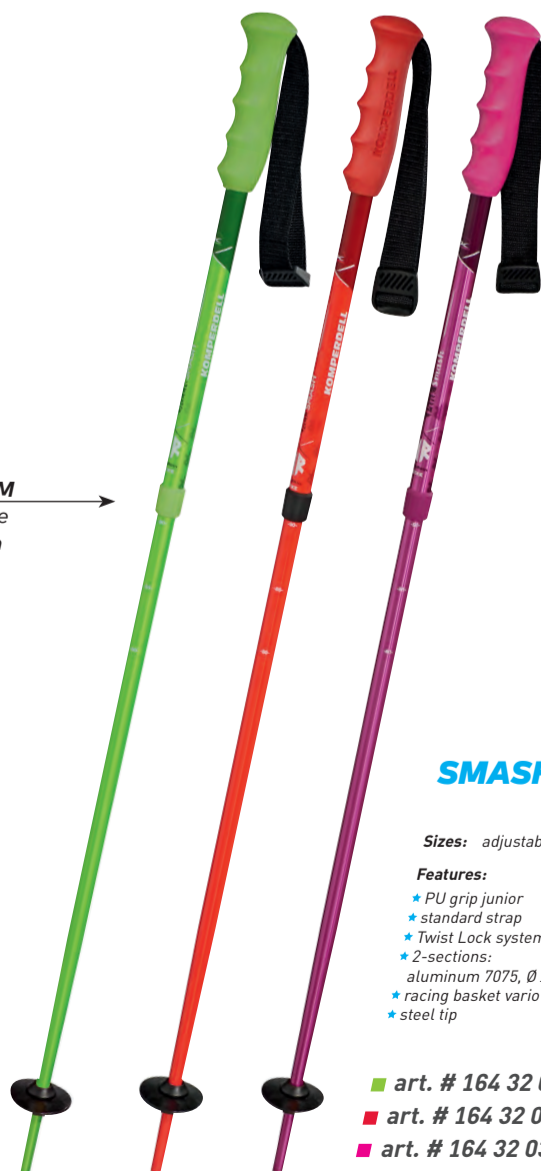

3 YEAR SERVICE
ON BATHING EDGE

SMASH SERIES

Sizes: adjustable from 80 - 105 cm

Features:

- * PU grip junior
- * standard strap
- * Twist Lock system
- * 2-sections: aluminum 7075, Ø 16/14 mm
- * racing basket vario
- * steel tip

- art. # 164 32 01-48 green
- art. # 164 32 02-03 red
- art. # 164 32 03-14 pink





CHAMP GREEN JUNIOR SUPER-G HENRIK

Sizes: 70 - 105 cm
(in 5 cm steps)

- Features:**
- ★ race grip junior
 - ★ standard strap
 - ★ aluminum 5086, Ø 16 mm, bent
 - ★ mini race basket
 - ★ steel tip

art. # 221 22 05-02



CHAMP PINK JUNIOR SUPER-G ALICE

Sizes: 70 - 105 cm
(in 5 cm steps)

- Features:**
- ★ race grip junior
 - ★ standard strap
 - ★ aluminum 5086, Ø 16 mm, bent
 - ★ mini race basket
 - ★ steel tip

art. # 221 22 06-02



CHAMP GREEN JUNIOR HENRIK

Sizes: 70 - 105 cm
(in 5 cm steps)

- Features:**
- ★ race grip junior
 - ★ standard strap
 - ★ aluminum 5086, Ø 14 mm
 - ★ mini race basket
 - ★ steel tip

art. # 211 22 12-02



CHAMP PINK JUNIOR ALICE

Sizes: 70 - 105 cm
(in 5 cm steps)

- Features:**
- ★ race grip junior
 - ★ standard strap
 - ★ aluminum 5086, Ø 14 mm
 - ★ mini race basket
 - ★ steel tip

art. # 211 22 13-02



CHAMP RED JUNIOR ALICE

Sizes: 70 - 105 cm
(in 5 cm steps)

- Features:**
- ★ race grip junior
 - ★ standard strap
 - ★ aluminum 5086, Ø 14 mm
 - ★ mini race basket
 - ★ steel tip

art. # 211 22 14-02





SABRE GRIP
safety grip
without strap



GREEN RUSH

Sizes: 70 - 105 cm
(in 5 cm steps)

Features:

- * Sabre grip junior
- * aluminum 5083, Ø 14 mm
- * mini racing basket
- * steel tip

art. # 211 22 07-48



BRIGHT YELLOW

Sizes: 70 - 105 cm
(in 5 cm steps)

Features:

- * race grip junior
- * junior strap
- * aluminum 5083, Ø 14 mm
- * mini racing basket
- * steel tip

art. # 211 33 05-15



REALLY PINK

Sizes: 70 - 105 cm
(in 5 cm steps)

Features:

- * race grip junior
- * junior strap
- * aluminum 5083, Ø 14 mm
- * mini racing basket
- * steel tip

art. # 211 22 08-28



EVERGREEN

Sizes: 70 - 105 cm
(in 5 cm steps)

Features:

- * race grip junior
- * junior strap
- * aluminum 5083, Ø 14 mm
- * mini racing basket
- * steel tip

art. # 211 22 09-48

ALPINE JUNIOR



THE SET FOR BEGINNERS
perfect for those first attempts at skiing



BLUE BOOST

Sizes: 70 - 105 cm
(in 5 cm steps)

Features:

- * race grip junior
- * junior strap
- * aluminum 5083, Ø14 mm
- * mini racing basket
- * steel tip

art. # 211 22 10-04



RED PEAK

Sizes: 70 - 105 cm
(in 5 cm steps)

Features:

- * race grip junior
- * junior strap
- * aluminum 5083, Ø14 mm
- * mini racing basket
- * steel tip

art. # 211 22 11-03



CHALLENGER

Sizes: 70 - 105 cm
(in 5 cm steps)

Features:

- * junior Jet grip
- * junior strap
- * aluminum 5083, Ø14 mm
- * mini racing basket
- * steel tip

art. # 211 11 03-10

KIDS SKI-SET

Sizes: 60 cm
70 cm

- * skiset for beginners
- * available in two lengths

■ art. # 201-115 Spike Boys

■ art. # 201-116 Lucy Girls



RENTAL ALPINE

HIGH QUALITY CARBON POLES WITH A 2-YEAR BREAKAGE GUARANTEE

This extreme light and stable alpine pole will be highly valued by your customers.

NEW



POWERLOCK 3.0
highly rigid, anodized aluminum for maximum holding power!

RENTAL VARIO CARBON

Sizes: Adult: adjustable from 110 - 140 cm

Features:

- * Race grip Duplo
- * Comfort strap
- * 2-sections:
 - Upper part: Aluminium 7075-T6, Ø 18 mm
 - Lower part: Carbon, Ø 16 mm
- * Powerlock 3.0 mechanism
- * Regular UL Basket
- * Flex steel tip

art. # 184 24 30-10



RENTAL VARIO TI ADULT / JUNIOR

Sizes: Adult: adjustable from 110 - 140 cm
Junior: adjustable from 80 - 105 cm

Features:

- * Race grip Duplo / Race grip Junior
- * Comfort strap / Standard strap
- * 2-teilig:
 - Oberteil: Aluminium 7075-T6, Ø 18 mm
 - Unterteil: Aluminium, Ø 16 mm / Aluminium, Ø 14 mm
- * Powerlock 3.0 mechanism / Twist Lock
- * Regular UL Basket / Mini UL Basket
- * Flex steel tip / steel tip

art. # 184 24 31-10 Adult
art. # 164 23 16-10 Junior



RENTAL ALPINE

HIGH QUALITY CARBON POLES WITH A 2-YEAR BREAKAGE GUARANTEE

This extreme light and stable alpine pole will be highly valued by your customers.

➔ **THE MOST COMPREHENSIVE RENTAL PROGRAM KOMPERDELL HAS EVER PRESENTED**
We provide premium poles, protectors and snowshoes. Ideal for rental.

➔ **INDIVIDUAL LOGO PRINTING**
Only small quantities are required to personalize poles, snowshoes or protectors with your logo.

➔ **ONLY THE BEST SERVICE IS JUST GOOD ENOUGH**
As we are convinced of the quality of our products, we grant a **2-year breakage warranty** on all carbon poles.

OPTIONAL GRIPS:



EVA FOAM GRIP

art. # 847-02



LIGHTNING DUPLO GRIP

art. # 8047-110



RENTAL CARBON ADULT / JUNIOR

Sizes: Adult: 110 - 135 cm (in 5 cm Steps)
Junior: 80 - 105 cm (in 5 cm Steps)

Features:

- ★ PU grip with Komperdell logo / KW JET PE grip
- ★ system strap XL / standard strap
- ★ carbon, Ø 13 mm
- ★ mini race basket
- ★ flex steel tip

art. # 146 23 10-10 adult
art. # 146 22 10-10 junior

COLOUR CODE VIA POLE TIPS
a different colour per length (sizes in cm)

70	75	80	85	90
95	100	105	110	115
120	125	130	135	



RENTAL SOFT CLEAR THERMO ADULT / JUNIOR

Sizes: Adult: 110 - 135 cm (in 5 cm steps)
Junior: 70 - 105 cm (in 5 cm steps)

Features:

- ★ PU Softgrip / KW Jet PE Griff
- ★ system strap XL / Junior strap
- ★ Alu 7075-T6, Ø 19 mm / Alu 5083, Ø 16 mm
- ★ mini race basket
- ★ flex steel tip

art. # 144 23 09-10 adult
art. # 221 23 09-10 junior

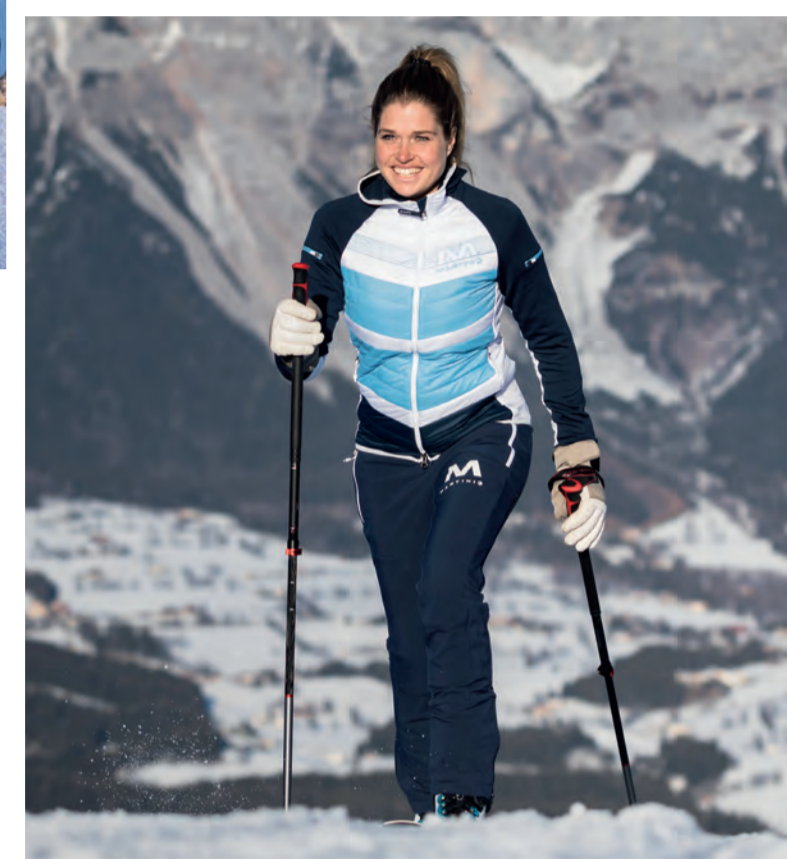

RENTAL TOURING

HIGH QUALITY POLES WITH A 2-YEAR BREAKAGE GUARANTEE

Whether the pole is being used for touring or snowshoeing, by providing a telescopic pole the correct length will always be available.



POWERLOCK 3.0
highly rigid, anodized
aluminum for maximum
holding power!

RENTAL TOUR CARBON

Sizes: adjustable from 105 - 140cm (in 5cm steps)

Weight: 190 grams

Features:

- * Contour Foam grip
- * System strap
- * 2-sections:
Upper part: Aluminum, Ø 16 mm
Lower part: Carbon, Ø 14mm
- * Large UL vario basket
- * Flex Tungsten/Carbide tip

art. # 184 23 88-10

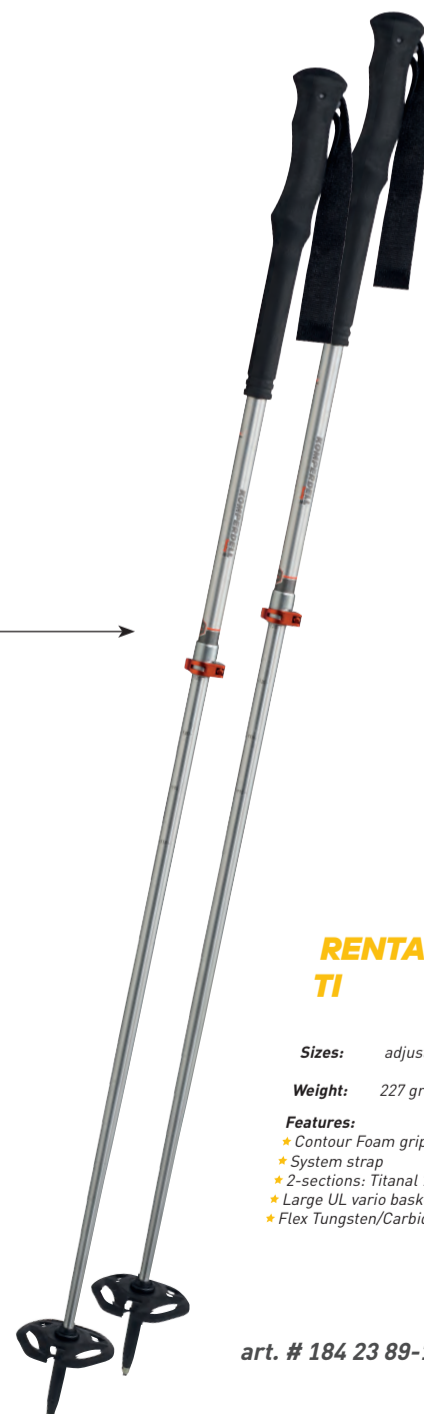

RENTAL TOUR TI

Sizes: adjustable from 105 - 140cm

Weight: 227 grams

Features:

- * Contour Foam grip
- * System strap
- * 2-sections: Titanal 7075-T6, Ø 18/16 mm
- * Large UL vario basket
- * Flex Tungsten/Carbide tip

art. # 184 23 89-10



NORDIC RENTAL VARIO

Sizes: adjustable from 110 - 150 cm

Weight: 229 grams

Features:

- ★ Nordic Foam grip
- ★ padded Nordic strap
- ★ 2-sections: Titanal .HF 7075-T6, Ø 18/16 mm
- ★ Powerlock 3.0 mechanism
- ★ BC Nordic basket
- ★ Nordic steel tip

art. # 184 23 90-02



NORDIC CARBON RENT

Sizes: 120 - 180 cm (in 5 cm steps)

Weight: 170 grams (155 cm)

Features:

- ★ Nordic 2K rubber grip
- ★ Click-In race strap
- ★ Carbon, Ø 16mm
- ★ weight 100g/150cm/bending 17.5 mm
- ★ Nordic trail UL basket
- ★ Carbid tip

art. # 520 23 17-10



RENTAL SNOWSHOES



RENTAL SNOWSHOES

LIGHT AND DURABLE

The high performance aluminum frame and Hypalon Decking create durable and lightweight snowshoes. Additionally the Easy-Step-In Binding will guarantee maximum comfort.



T30 red

PEAKMASTER SNOWSHOE 30

Size: T30 - up to 120 kg (baggage included)

Weight: T30 - 975 grams/piece

Features:

- * Anodized High-Performance Aluminum Frame
- * Durable Hypalon decking
- * Steel Front claw and middle claw for traction in different conditions
- * Heel Lift
- * Easy Step-In Binding in 3 sizes available



T25 blue

PEAKMASTER SNOWSHOE 25

Size: T25 - up to 100 kg (baggage included)

Weight: T25 - 905 grams/piece

Features:

- * Anodized High-Performance Aluminum Frame
- * Durable Hypalon decking
- * Steel Front claw and middle claw for traction in different conditions
- * Heel Lift
- * Easy Step-In Binding in 3 sizes available



T22 ribes

PEAKMASTER SNOWSHOE 22

Size: T22 - up to 80 kg (baggage included)

Weight: T22 - 833 grams/piece

Features:

- * Anodized High-Performance Aluminum Frame
- * Durable Hypalon decking
- * Steel Front claw and middle claw for traction in different conditions
- * Heel Lift
- * Easy Step-In Binding in 3 sizes available

■ art. # 6576-10 T30 red

■ art. # 6577-10 T25 blue

■ art. # 6578-10 T22 ribes

NORDIC XC CX-80



CX-80

THE LIGHTEST AND STIFFEST POLES
FOR MAXIMUM SPEED

By far the best shafts worldwide –
unsurpassed in the ratio of weight to stiffness.

TUBE CAN BE CUT TO
INDIVIDUAL LENGTH
to the optimal length for
ambitious athletes

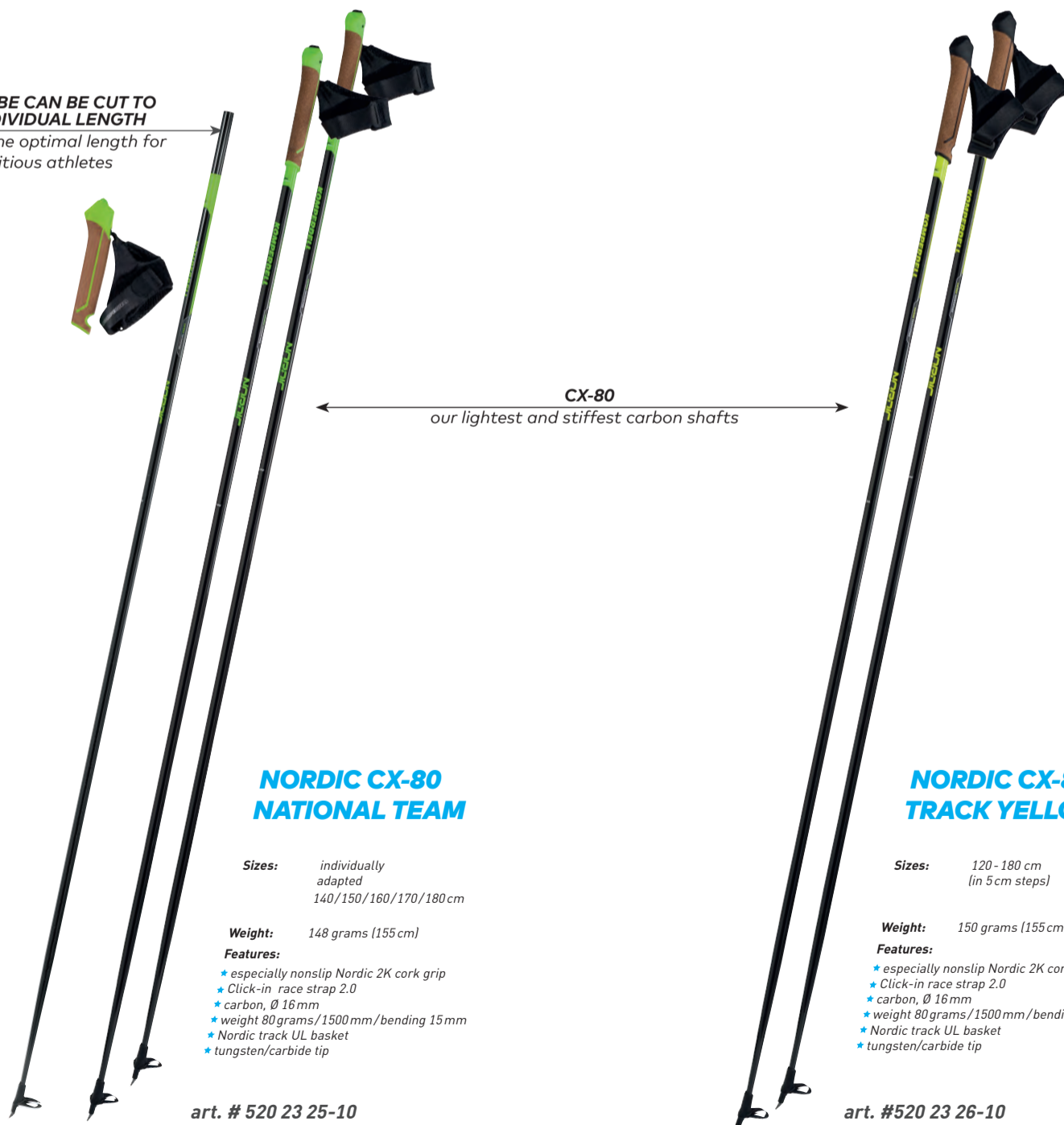

NORDIC CX-80 NATIONAL TEAM

Sizes: individually
adapted
140/150/160/170/180 cm

Weight: 148 grams (155 cm)

Features:

- * especially nonslip Nordic 2K cork grip
- * Click-in race strap 2.0
- * carbon, Ø 16 mm
- * weight 80 grams/1500 mm/bending 15 mm
- * Nordic track UL basket
- * tungsten/carbide tip

art. # 520 23 25-10

NORDIC CX-80 TRACK YELLOW

Sizes: 120 - 180 cm
(in 5 cm steps)

Weight: 150 grams (155 cm)

Features:

- * especially nonslip Nordic 2K cork grip
- * Click-in race strap 2.0
- * carbon, Ø 16 mm
- * weight 80 grams/1500 mm/bending 15 mm
- * Nordic track UL basket
- * tungsten/carbide tip

art. #520 23 26-10

Rembrandtin

SIZE CHART FOR SKATING & RACING

Person	Man	Woman
140 cm	120 cm	
145 cm	125 cm	
150 cm	130 cm	
155 cm	135 cm	
160 cm	140 cm	
165 cm	145 cm	
170 cm	150 cm	
175 cm	155 cm	
180 cm	160 cm	
185 cm	165 cm	
190 cm	170 cm	
195 cm	175 cm	
200 cm	180 cm	



NORDIC XC CX-100



CX-100

PERFECT BALANCE BETWEEN
WEIGHT AND STIFFNESS

The CX-100 poles are the best choice for ambitious amateur athletes to support their performance in all conditions.



NATURAL CORK GRIP
sweat absorbing and light

EXTRA STIFF CX-100 SHAFT
improved transmission of force

SIZE CHART FOR CLASSIC & SKATING

140 cm	120 cm
145 cm	125 cm
150 cm	130 cm
155 cm	135 cm
160 cm	140 cm
165 cm	145 cm
170 cm	150 cm
175 cm	155 cm
180 cm	160 cm
185 cm	165 cm
190 cm	170 cm
195 cm	175 cm
200 cm	180 cm

SIZE CHART FOR CLASSIC & SKATING

140 cm	110 cm
145 cm	115 cm
150 cm	120 cm
155 cm	125 cm
160 cm	130 cm
165 cm	135 cm
170 cm	140 cm
175 cm	145 cm
180 cm	150 cm
185 cm	155 cm
190 cm	160 cm
195 cm	165 cm
200 cm	170 cm

NORDIC CX-100 CORK

Sizes: 120 - 180 cm
(in 5 cm steps)

Weight: 168 grams (155cm)

Features:

- * padded Nordic 2K Cork grip
- * Click-in strap 2.0
- * carbon, Ø 16 mm
- * weight 100g/150cm/bending 17.5mm
- * Nordic trail UL basket
- * tungsten/carbide tip

■ art. # 520 23 27-10 yellow
■ art. # 520 23 28-10 red
■ art. # 520 23 29-10 blue
■ art. # 520 23 30-10 pink

NORDIC CX-100 SPORT

Sizes: 120 - 180 cm
(in 5 cm steps)

Weight: 170 grams (155cm)

Features:

- * especially nonslip Nordic 2K rubber grip
- * Click-in strap 2.0
- * carbon, Ø 16 mm
- * weight 100g/150cm/bending 17.5mm
- * Nordic trail UL basket
- * tungsten/carbide tip

■ art. # 520 23 17-10 yellow
■ art. # 520 23 18-10 red
■ art. # 520 23 19-10 blue
■ art. # 520 23 20-10 pink

NORDIC XC ADVENTURE



3 YEAR SERVICE
NO BUCKLING SAFETY

SIZE CHART FOR CLASSIC & TOURING	
♀	♂
140 cm	110 cm
145 cm	115 cm
150 cm	120 cm
155 cm	125 cm
160 cm	130 cm
165 cm	135 cm
170 cm	140 cm
175 cm	145 cm
180 cm	150 cm
185 cm	155 cm
190 cm	160 cm
195 cm	165 cm
200 cm	170 cm

NORDIC ADVENTURE VARIO

Sizes: adjustable from 110 - 155 cm

Features:

- * Nordic foam grip
- * padded Nordic strap
- * 2-sections: aluminum 7075, Ø 18/16mm
- * Powerlock 3.0 mechanism
- * BC Nordic basket
- * Nordic steel tip

art. # 184 23 64-02

NORDIC ADVENTURE

Sizes: 120 - 160 cm (in 5 cm steps)

Features:

- * Nordic foam grip
- * padded Nordic strap
- * aluminum 5086, Ø 16mm
- * BC Nordic basket
- * Nordic steel tip

art. # 522 23 10-02

NORDIC PRIME

Sizes: 120 - 160 cm (in 5 cm steps)

Features:

- * XC cork grip
- * padded Nordic strap
- * aluminum 5086, Ø 16mm
- * XC standard basket
- * Nordic steel tip

art. # 522 23 11-12

NORDIC CLASSIC

Sizes: Adult: 120 - 160 cm
Junior: 90 - 115 cm (in 5 cm steps)

Features:

- * Nordic XC grip
- * Nordic classic strap
- * aluminum 5083, Ø 16mm
- * XC standard basket
- * Nordic steel tip

art. # 522 11 02-10 adult
art. # 222 11 21-10 junior



**GERLINDE
 KALTENBRUNNER**

**PETER
 HABELER**

TOURING

THE LIGHTEST POLE ON THE MARKET – 100% MADE IN AUSTRIA

We are the experts for ultra light products made of carbon and composite materials due to decades of experience and a high level of technical know-how in manufacturing. This enabled us to create the most lightweight touring program on the market. We are the only brand that can supply this variety of touring poles perfectly matching ski tourers requirements.



TOURING GRIP

The special designed grip shape can be used to adjust almost all touring bindings on the market. Additionally, most of our touring poles feature an extended grip zone to be able to grip on different positions on steep terrain.



28°
 adapts to the
 slope - up to 28°

ICE-FLEX BASKET

With the moveable ice-flex system the floating basket adapts to the slope up to 28°. This feature increases your safety, especially in steep terrain and on hard surfaces. Despite the large basket the tip still finds a secure hold.

THE STRONGEST LOCKING MECHANISM ON THE MARKET

We are the only ones who produce a locking system entirely made of aluminum. This Powerlock 3.0 guarantees absolutely safety with a holding power of up to 200 kg and is not affected by any weather conditions at all.



3 YEARS FREE REPAIR SERVICE

Komperdell guarantees highest quality and unique service. We repair your poles, no matter what or how it happened. Because for us, sustainability means a conscious, long-term approach to our environment – to nature and, above all, to our customers. This is one of our approaches for sustainability.



FREERIDE FATSO



©WINTERSPORT.NL



©WINTERSPORT.NL



FATSO

THE POLE FOR THE REAL FREE RIDERS

Especially wide, extra light and long anti-slipping grip-zone for the best comfort accompanied by an easy to adjust powder strap.



FELIX WIEMERS
Germany's best freerider

POWERLOCK 3.0
highly rigid, anodized aluminum for maximum holding power!

3 YEAR SERVICE
ICE-FLEX BASKET
adapts to the slope – up to 28°

FATSO CARBON TEAM VARIO

Sizes: packed size: 107 cm
adjustable from 110 - 140 cm

Weight: 257 grams

Features:

- * Fatso 430 grip
- * Powder Padded strap
- * 2-sections: upper part: aluminum 7075-T6, Ø16 mm lower part: carbon, Ø14 mm
- * Powerlock 3.0 mechanism
- * XL ice-flex basket
- * ice-flex tungsten carbide-tip

art. # 175 20 05-10

3 YEAR SERVICE

FATSO VARIO TI

Sizes: packed size: 107 cm
adjustable from 110 - 140 cm

Weight: 268 grams

Features:

- * Fatso 430 grip
- * Powder Padded strap
- * 2-sections: aluminum 7075-T6, Ø18/16 mm
- * Powerlock 3.0 mechanism
- * XL ice-flex basket
- * ice-flex tungsten carbide tip

art. # 184 23 97-20

3 YEAR SERVICE

FATSO VARIO TI

Sizes: packed size: 107 cm
adjustable from 110 - 140 cm

Weight: 268 grams

Features:

- * Fatso 430 grip
- * Powder Padded strap
- * 2-sections: aluminum 7075-T6, Ø18/16 mm
- * Powerlock 3.0 mechanism
- * XL ice-flex basket
- * ice-flex tungsten carbide tip

art. # 184 23 96-66

TOURING D'SCENT



3 YEAR SERVICE
NO QUESTIONS ASKED

97 cm

POWERLOCK 3.0
highly rigid, anodized
aluminum for maximum
holding power!

D'SCENT CARBON VARIO

Sizes: packed size: 97 cm
adjustable from 110 - 140 cm

Features:

- * X-Touring Foam 280 Camo grip
- * extended grip zone
- * Click-In 2.1 Ergo strap with strap change system
- * 2-sections:
upper part: aluminum 7075-T6, Ø 16mm
lower section: carbon, Ø 14mm
- * Powerlock 3.0 mechanism
- * large UL ice-flex basket
- * ice-flex tungsten/carbide tip

art. # 175 23 72-10

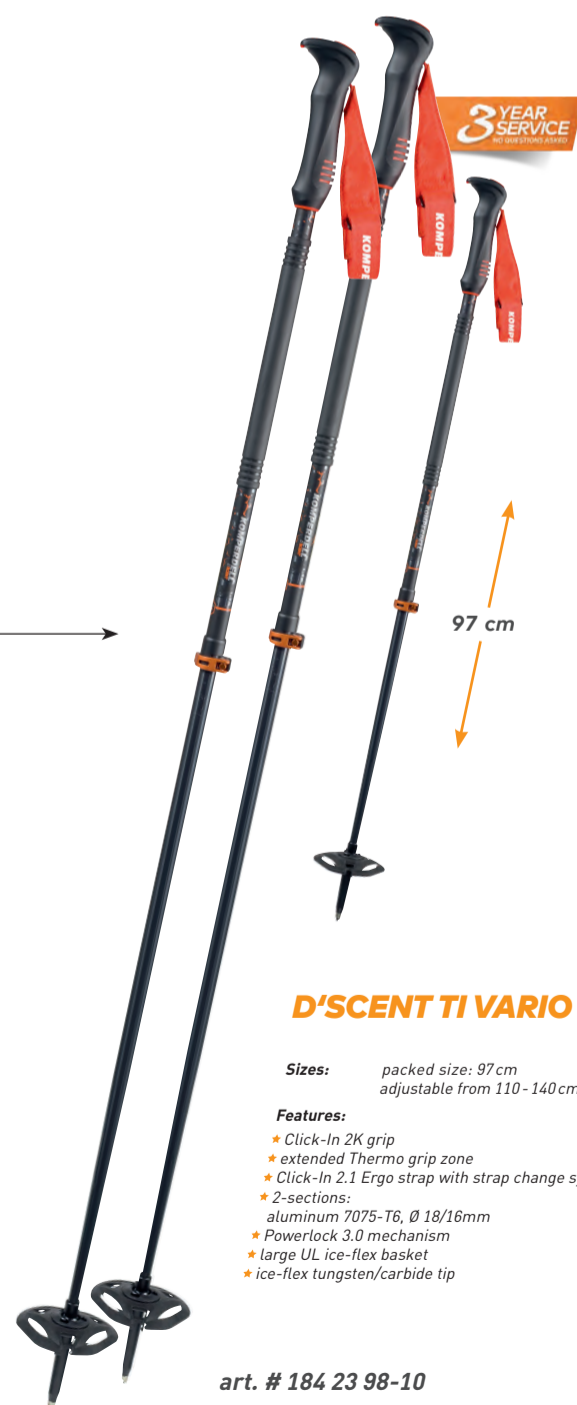

3 YEAR SERVICE
NO QUESTIONS ASKED

97 cm

D'SCENT TI VARIO

Sizes: packed size: 97 cm
adjustable from 110 - 140 cm

Features:

- * Click-In 2K grip
- * extended Thermo grip zone
- * Click-In 2.1 Ergo strap with strap change system
- * 2-sections:
aluminum 7075-T6, Ø 18/16mm
- * Powerlock 3.0 mechanism
- * large UL ice-flex basket
- * ice-flex tungsten/carbide tip

art. # 184 23 98-10

TOURING D'SCENT



D'SCENT CARBON

Sizes: 110 - 135 cm
(in 5 cm steps)

Features:

- * X-Tour Click-In Foam Camo grip
- * Click-In 2.1 Ergo strap with strap change system
- * carbon, Ø 16mm
- * regular UL ice-flex basket
- * ice-flex tungsten/carbide tip

art. # 148 23 50-10



D'SCENT TI FREERIDE

Sizes: 110 - 135 cm
(in 5 cm steps)

Features:

- * Click-In 2K grip
- * extended Thermo grip zone
- * Click-In 2.1 Ergo strap with strap change system
- * aluminum 7075-T6, Ø 18mm
- * large UL ice-flex basket
- * ice-flex tungsten/carbide tip

art. # 134 23 09-10

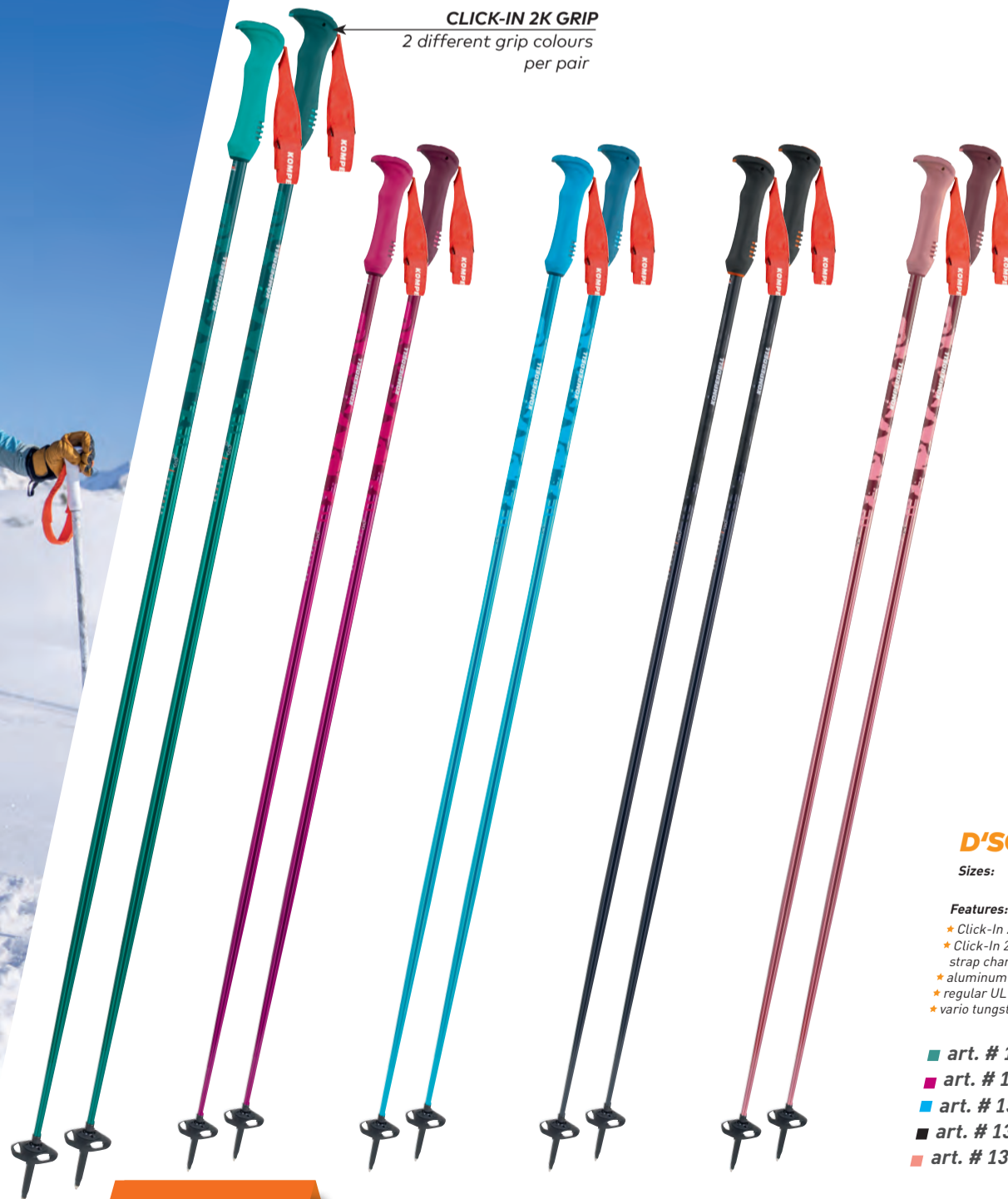

CLICK-IN 2K GRIP
2 different grip colours per pair

ERGO STRAP
also available in black



D'SCENT TI

Sizes: 110 - 135 cm
(in 5 cm steps)

Features:

- * Click-In 2K grip
- * Click-In 2.1 Ergo strap with strap change system
- * aluminum 7075-T6, Ø 16mm
- * regular UL ice-flex basket
- * vario tungsten/carbide tip

- art. # 139 23 05-20 mint
- art. # 139 23 06-33 berry
- art. # 139 23 04-04 blue
- art. # 139 23 07-12 steelgrey
- art. # 139 23 08-68 rosegold

TOURING ULTRALIGHT



C2 ULTRALIGHT

THE LIGHTEST POLE – 188 GRAMS ONLY

We are the expert for carbon poles. Only we develop, design and manufacture our shafts in our own factory. This enables us to produce the poles 20% lighter than any other brand with maintaining the same quality.



3 YEAR SERVICE
FOR BACKLINE SKI POLES



3 YEAR SERVICE
FOR BACKLINE SKI POLES

POWERLOCK 3.0
highly rigid, anodized
aluminum for maximum
holding power!



98 cm

ICE FLEX BASKET
adapts to the slope -
up to 28°

CARBON C2 ULTRALIGHT

Sizes: packed size: 98 cm
adjustable from 110 - 140 cm

Weight: 188 grams

Features:

- * Touring Foam 280 grip
- * extended grip zone
- * Comfort Padded strap
- * 2-sections:
upper part: carbon Cloud, Ø 16mm
lower part: carbon Composite, Ø 14mm
- * Powerlock 3.0 mechanism
- * large UL ice-flex basket
- * ice-flex tungsten/carbide tip

- art. # 175 23 75-10 orange
- art. # 175 23 76-10 berry

98 cm

CARBON C7 ASCENT

Sizes: packed size 98 cm
adjustable from 110 - 140 cm

Weight: 239 grams

Features:

- * Touring Fatso grip
- * extended grip zone
- * Comfort Padded strap
- * 2-sections:
carbon, Ø 18/16mm
- * Powerlock 3.0 mechanism
- * large UL ice-flex basket
- * ice-flex tungsten/carbide tip

- art. # 175 23 77-10 green
- art. # 175 23 78-10 blue
- art. # 175 23 79-10 berry



CONTOUR TITANAL

THE POLE FOR ENTHUSIASTIC MOUNTAINEERS

The ultra-light and almost indestructible pioneer among the touring poles has been in our collection for 20 years. Consistently improved, it is still the pole that true passionate mountaineers rely on today.



3 YEAR SERVICE

FREE TOURING JUNIOR

Sizes: packed size: 95 cm
adjustable from 100-130 cm

- Weight:** 225 grams
- Features:**
- * Touring Foam Camo 280 grip
 - * extended grip zone
 - * Comfort Padded strap
 - * 2-sections: aluminum 7075-T6, Ø 18/16mm
 - * Powerlock 3.0 mechanism
 - * regular UL Vario basket
 - * vario tungsten/carbide flex tip

art. # 164 23 15-10



3 YEAR SERVICE

FREE TOURING TI

Sizes: packed size: 100 cm
adjustable from 110 - 140 cm

- Weight:** 239 grams
- Features:**
- * Touring Foam 280 grip
 - * extended grip zone
 - * Comfort Padded strap
 - * 2-sections: upper part: aluminum 7075-T6, Ø 18mm lower part: Titanal Ti-7 Ø 16mm
 - * Powerlock 3.0 mechanism
 - * large UL Vario basket
 - * ice-flex tungsten/carbide tip

art. # 184 23 81-02



3 YEAR SERVICE

CONTOUR TITANAL II FOAM

Sizes: packed size: 85 cm
adjustable from 105-140 cm

- Weight:** 230 grams
- Features:**
- * Touring Foam 450 grip
 - * extra long grip zone
 - * Comfort Padded strap
 - * 2-sections: Titanal.HF, Ø 16/14mm
 - * Powerlock 3.0 mechanism
 - * large UL Vario basket
 - * vario tungsten/carbide flex tip

art. # 188 23 05-10



3 YEAR SERVICE

CONTOUR TITANAL II FOAM PINK

Sizes: packed size: 85 cm
adjustable from 105 - 140 cm

- Weight:** 230 grams
- Features:**
- * Touring Foam 450 grip
 - * extra long grip zone
 - * Comfort Padded strap
 - * 2-sections: Titanal.HF, Ø 16/14mm
 - * Powerlock 3.0 mechanism
 - * large UL Vario basket
 - * vario tungsten/carbide flex tip

art. # 188 23 06-10

TOURING ALUMINUM



THERMO ASCENT TI 3

Sizes: packed size: 72 cm
adjustable from 115 - 150 cm

Features:

- * EVA foam grip
- * Thermogrip foam
- * system strap XL
- * 3-sections:
aluminum 7075-T6, Ø 18/16/14 mm
- * Powerlock 3.0 mechanism
- * vario winter basket
- * vario tungsten/carbide flex tip

art. # 174 23 54-10



FREE TOURING THERMO ADVENTURE

Sizes: packed size: 100 cm
adjustable from 110 - 140 cm

Features:

- * EVA foam grip
- * extended Thermo grip zone
- * system strap XL
- * 2-sections:
upper part: aluminum 7075-T6, Ø 18 mm
lower part: Titanal Ti 7, Ø 16 mm
- * Powerlock 3.0 mechanism
- * LARGE UL Vario basket
- * vario tungsten/carbide flex tip

art. # 184 23 94-10



T2 THERMO ADVENTURE

Sizes: packed size: 85 cm
adjustable from 115 - 150 cm

Features:

- * EVA foam grip
- * extended Thermo grip zone
- * system strap XL
- * 2-sections:
aluminum 7075-T6, Ø 18/16 mm
- * Powerlock 3.0 mechanism
- * vario winter basket
- * vario tungsten/carbide flex tip

art. # 184 23 95-10

TOURING SPLITBOARDING



AWARDED WITH

OutDoor

by ISPO

Outstanding Outdoor

Gold Winner 2019

an ISPO Award



CARBON FXP.4 EXPEDITION VARIO

Sizes: packed size: 43 cm
adjustable from 120 - 140 cm

Weight: 248 grams

Features:

- * Touring Foam 280 grip
- * extended grip zone
- * Comfort Padded strap
- * 4-section: upper section: aluminum 7075-T6, Ø 18mm lower section: Carbon Composite, Ø 16mm
- * Powerlock 3.0 mechanism
- * FXP folding mechanism
- * Regular UL FXP basket
- * Ice-Flex tungsten/carbide tip

art. # 194 23 61-10



CARBON FXP.4 EXPEDITION VARIO COMPACT

Sizes: packed size: 38 cm
adjustable from 105 - 125 cm

Weight: 237 grams

Features:

- * Touring Foam 280 grip
- * extended grip zone
- * Comfort Padded strap
- * 4-section: upper section: aluminum 7075-T6, Ø 18mm lower section: Carbon Composite, Ø 16mm
- * Powerlock 3.0 mechanism
- * FXP folding mechanism
- * Regular UL FXP basket
- * Ice-Flex tungsten/carbide tip

art. # 194 23 62-10



CARBON CXP PRO

Sizes: packed size: 65 cm
adjustable from 105 - 140 cm

Weight: 241 grams

Features:

- * TOURING FOAM 450 grip
- * Comfort Padded strap
- * 3-sections: upper part: carbon, Ø 18 mm middle section: carbon, Ø 16 mm lower part: Titanal.HF, Ø 14 mm
- * Powerlock 3.0 mechanism
- * large UL basket
- * vario tungsten/carbide flex tip

art. # 175 23 54-10

AMAG
ROLLING



TITANAL EXP PRO

Sizes: packed size: 65 cm
adjustable from 105 - 140 cm

Weight: 262 grams

Features:

- * TOURING FOAM 450 grip
- * Comfort Padded strap
- * 3-sections: Titanal.HF, Ø 18/16/14 mm
- * Powerlock 3.0 mechanism
- * large UL basket
- * vario tungsten/carbide flex tip

art. # 174 23 55-10



POWERLOCK 3.0
highly rigid, anodized aluminum for maximum holding power!



TOURING SPEED CARBON



Trail Click-In 2.1 strap



SPEED TOUR CARBON VARIO

Sizes: adjustable from 110 - 140 cm

Weight: 172 grams

Features:

- ★ Trail Pro Cork 245 grip
- ★ Trail Click-In 2.1 strap
- ★ 2-sections: carbon, Ø 18/16 mm
- ★ Nordic Speed basket
- ★ ice flex tip

art. # 175 23 65-10

← POWDER PADDED STRAP sold separately →



SPEED TOUR CARBON PRO

Sizes: 115- 145 cm (in 5cm steps)

Weight: 168 grams (125cm)

Features:

- ★ Trail Pro Cork 245 grip
- ★ Trail Click-In 2.1 strap
- ★ CX-100 carbon
- ★ Nordic Speed basket
- ★ ice flex tungsten/carbide tip

art. # 148 23 44-10



SPEED TOUR CARBON

Sizes: 115- 145 cm (in 5cm steps)

Weight: 154 grams (125cm)

Features:

- ★ EVA Cork Click-In Nordic grip
- ★ NW Click-In 2.0 strap
- ★ CX-100 carbon
- ★ Nordic BC basket
- ★ tungsten/carbide tip

art. # 148 23 45-10



SPEED TOUR TI VARIO

Sizes: adjustable from 110 - 140 cm

Weight: 232 grams

Features:

- ★ Trail Pro Cork 245 grip
- ★ Trail Click-In 2.1 strap
- ★ 2-sections:
- ★ Titanal 7075-T6, Ø 18/16 mm
- ★ Nordic Speed basket
- ★ ice flex tip

art. # 184 23 93-02



POWDER PADDED STRAP
sold separately

SPEED TOUR TI PRO

Sizes: 115- 145 cm (in 5cm steps)

Weight: 213 grams (125cm)

Features:

- ★ Trail Pro Cork 245 grip
- ★ Trail Click-In 2.1 strap
- ★ Titanal 7075-T6
- ★ Nordic Speed basket
- ★ ice flex tip

art. # 524 23 14-02



SPEED TOUR TI

Sizes: 115- 145 cm

Weight: 193 grams (125cm)

Features:

- ★ EVA Cork Click-In Nordic grip
- ★ NW Click-In 2.0 strap
- ★ Titanal 7075-T6
- ★ Nordic BC basket
- ★ tungsten/carbide tip

art. # 524 23 15-02



SNOWSHOES

100% CARBON

We offer the lightest snowshoe on the market fully made from carbon. The result is truly amazing - 50 % less weight on your foot makes all the difference! You will feel it on every single step.



THE MOST LIGHTWEIGHT SNOWSHOE IN THE WORLD

The full snowshoe will be laminated in one single step in production. The use of ultralight Carbon and this unique production process saves more than 50% in weight without sacrificing any strength.

MAXIMUM TRACTION

Ice Rail Claws, made from stainless steel, are laminated directly into the frame and provide tons of traction on ice and hard packed snow.

KEEP YOUR FEET WARM AND DRY

The insulated neoprene toe cover keeps your feet warm and dry, even in deep snow. It's very easy to attach it to the binding.

NEW QUICKLOCK BINDING

The new quicklock binding with lacing system is way easier to get in and covers your shoe for perfect fit. Especially for women it is an absolute game-changer regarding comfort well-being.



CARBON SNOWSHOES



CARBON SNOWSHOES

THE WORLD'S 1ST SNOWSHOES MADE OF CARBON

50% less weight and incredible traction on ice and hard packed snow.



QUICKLOCK BINDING

super easy to adjust, fitting all sizes and types of boots and offering perfect hold



3 YEAR SERVICE
NO QUESTIONS ASKED



QUICKLOCK BINDING

super easy to adjust, fitting all sizes and types of boots and offering perfect hold



3 YEAR SERVICE
NO QUESTIONS ASKED

CARBON AIR FRAME 25

Sizes: M, L

Weight: 691 grams/piece

Features:

- * integral built carbon decking
- * hollow-core carbon frame – especially light carbon frame, 50% less weight
- * ice-rail claws – incredible traction on ice and hard packed snow
- * New Quicklock binding – super easy to adjust, fitting all sizes and types of boots and offering perfect hold
- * Toe cover

art. # 6508-10

COMPOSITE AIR FRAME

Sizes: M, L

Weight: 748 grams/piece

Features:

- * integral built composite decking
- * hollow-core composite frame – especially light composite frame, 40% less weight
- * ice-rail claws for optimal traction
- * New Quicklock binding – super easy to adjust, fitting all sizes and types of boots and offering perfect hold
- * Toe cover

art. # 6368-10

ALUMINUM SNOWSHOES



ALUMINUM SNOWSHOES

LIGHT AND DURABLE

The high performance aluminum frame and the Hypalon Decking make the snowshoes durable and lightweight. With the new Quicklock Binding you will get maximum comfort. We created a snowshoe program that covers all requirements of our customers.



T30 red

PEAKMASTER PRO SNOWSHOE 30

Size: T30 - up to 120 kg (baggage included)

Weight: T30 - 975 grams/piece

Features:

- * anodized High-Performance Aluminum Frame
- * durable Hypalon decking
- * steel front claw and middle claw for traction in different conditions
- * Heel Lift
- * Quicklock Binding in 2 sizes available

■ art. # 6640-10 T30 red



T25 blue

PEAKMASTER PRO SNOWSHOE 25

Size: T25 - up to 100 kg (baggage included)

Weight: T25 - 905 grams/piece

Features:

- * anodized High-Performance Aluminum Frame
- * durable Hypalon decking
- * steel front claw and middle claw for traction in different conditions
- * Heel Lift
- * Quicklock Binding in 2 sizes available

■ art. # 6641-10 T22 blue



T22 ribes

PEAKMASTER PRO SNOWSHOE 22

Size: T22 - up to 80 kg (baggage included)

Weight: T22 - 833 grams/piece

Features:

- * anodized High-Performance Aluminum Frame
- * durable Hypalon decking
- * steel front claw and middle claw for traction in different conditions
- * Heel Lift
- * Quicklock Binding in 2 sizes available

■ art. # 6642-10 T22 ribes

SNOWSHOE ACCESSORIES



SNOWSHOE TOE COVER

- Sizes: S, M, L
- Features:
- keeps your feet dry and warm
 - easy attachment to the binding by push button system

art. # 6574-925



SNOWSHOE GAITER

- Sizes: S, L
- Features:
- protects from wind, moisture and cold
 - optimal fit, easy length adjustment with cord

art. # 6575-925



SNOWSHOE SOCKS TITANIUM 0,5 MM

- Sizes: 35/36-47/48
- Features:
- Seamless Bonding System for honest wearing comfort
 - suitable for normal outdoor shoes
 - keeps your feet dry and warm

art. # 6573-925



QUICKLOCK SNOWSHOE BINDING

- Sizes: M, L
- Features:
- separate Quicklock Binding
 - suitable for normal outdoor shoes
 - best wearing comfort

art. # 6643-925



TPU SNOWSHOE BINDING

- Sizes: S, M, L
- Features:
- separate Easy-Step-In Binding
 - suitable for normal outdoor shoes
 - best wearing comfort

art. # 6572-925



PROTECTION #1

WE ARE A LEADER IN INNOVATIVE DEVELOPMENTS FOR PROTECTORS IN WINTER-, MOTORCYCLE-, BIKE- AND EQUESTRIAN SPORTS FOR MORE THAN 20 YEARS.

Komperdell is the only brand to develop not only the protective technology but also the appropriate garment. This results in a perfectly harmonizing protective system that fits perfectly and does not have to compromise on safety and comfort.



AWARD WINNING PROTECTION TECHNOLOGY

Our protectors offer maximum safety, have the biggest continuous protection zone and are leading in residual force values. In case of a fall our protectors absorb up to 93% of the impact energy due to the long-lasting, innovative layered structure of the protectors, which does not lose its effectiveness even years later. Our protector technology has already won more than 50 international awards.



ONE-STOP INNOVATION

The protector as well as the garment are developed in our headquarters in Mondsee from the first idea up to the final product. Apart from our own brand, we develop, design and manufacture protectors for a number of leading brands in the sports and motorcycle sector.

25 YEARS OF KNOW-HOW

For more than 20 years we develop for and with leading brands of the motorcycle industry. Thus we can use our valuable know-how of the most extreme field of use for efficient protection garments also for winter-, equestrian- and bike sports.





WINTERSPORTS

WHY A KOMPERDELL PROTECTOR?

We are the only brand to not only develop and manufacture the garment but also the protector itself. This gives us the opportunity to perfectly match protector and garment. Over the years we have been able to constantly improve our protector systems, so that our new protectors are once again 25% lighter and more flexible.



CROSSFLEX ATHLETIC A COMPLETELY NEW PROTECTOR SYSTEM

NEW PROTECTOR FOAM
our new foam is up to 25% lighter with the same impact protection

NEW

25% LIGHTER
CROSSFLEX ATHLETIC
25% lighter, perfectly ventilated and more flexible

TOP RESIDUAL FORCE VALUES
5,93 kN

ABSORBS UP TO 93% OF THE IMPACT ENERGY
top residual force

UNLIMITED MULTIPLE IMPACT CAPABILITY

UNLIMITED MULTI IMPACT CAPABILITY

CLEVER MULTILAYER SYSTEM
breathable and flexible, fits perfectly on the back

100% BREATHABLE

WASHABLE
our products can be washed without problems

WASHABLE

1 A COMPLETELY NEW PROTECTOR

As the only protector brand we design, develop and manufacture our protector inserts by our own. For the new generation of our Cross Flex protectors we have developed a new protector foam that is 25% lighter with the same impact protection and our typical multi-impact capability.

2 25% LIGHTER, MORE FLEXIBLE AND PERFECT BREATHABLE

Due to our typical multilayer construction and the seamless integration the protector fits perfectly in the garment. Additional 3D Mesh on the protector provides an optimal ventilation on the body. We don't make compromises on safety and comfort on our Cross Flex protector.



BALLISTIC SYSTEM

BRILLIANT ENGINEERING

With our Ballistic System you get two brilliant products in one: The chest protector can be replaced by a normal strap system so that it turns into a Backpack – unique and only from Komperdell.

1 SYSTEM = 2 BRILLIANT PRODUCTS



BALLISTIC SET WINTERSPORTS | BIKE | MOTORCYCLE

Sizes: XS - XL

Features:

- * multilayer Cross Flex Center-Back-protector made of adaptive dual-density foam, EN-approved 1621-2
- * ultimate mobility
- * removable chest protection, strap attached separately
- * slim kidney-belt for the perfect fit, adjustable with velcro fastener
- * Nutrition pocket at the lower back

- art. # 6602-206 Men
- art. # 6616-209 Women

BALLISTIC PACK WINTERSPORTS | BIKE | MOTORCYCLE

Sizes: XS - XL

Features:

- * multilayer Cross Flex Center-Back-protector made of adaptive dual-density foam, EN-approved 1621-2
- * ultimate mobility
- * removable strap
- * slim kidney-belt for the perfect fit, adjustable with velcro fastener
- * Nutrition pocket at the lower back

- art. # 6610-206 Men
- art. # 6617-209 Women



BALLISTIC & ARMOUR

PROTECTION AT THE HIGHEST LEVEL

Whether with 360° all around protection or additional protectors on the chest and on the sides – the Ballistic and Armour models offer the highest protection for off piste and safety conscious skiers.



BALLISTIC FLEX FIT

Sizes: Men: XXS-XXL
Women: XXS-XL

- Features:
- * multilayer Cross Flex back-protector, made of adaptive dual-density foam, EN-approved 1621-2
 - * light and flexible
 - * highest safety values - 360° all around protection
 - * for ultimate mobility
 - * front zip

art. # 6454-212 Men
art. # 6453-212 Women

ARMOUR VEST WINTERSPORTS | BIKE | MOTORCYCLE

Sizes: unisex, XS - XXL

- Features:
- * multilayer Cross Flex back-protector made of adaptive dual-density foam, EN-approved 1621-2
 - * light and flexible
 - * protection on the side to safeguard ribs and organs
 - * semi-removable chest protectors
 - * front zip

art. # 6600-206 unisex



AIR VEST

PERFECT COMBINATION OF SAFETY AND COMFORT

The Air Vest Models are light and flexible, and therefore hardly noticeable while wearing. A real classic for the slopes due to ultimate mobility and good ventilation.



**SEMI-REMOVABLE
CHEST PROTECTORS**
certified according to the
motorcycle standard
EN 1621-3

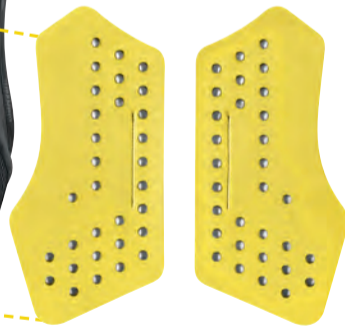

NEW! 25% LIGHTER AND EVEN
MORE FLEXIBLE

**EXTRA STRONG, ELASTIC
RUBBER BINDING**
to ensure a secure hold



NEW! 25% LIGHTER AND EVEN
MORE FLEXIBLE

AIR VEST + WINTERSPORTS | BIKE

Sizes: unisex, XS - XL

Features:

- * multilayer Cross Flex back-protector made of adaptive dual-density foam, EN-approved 1621-2
- * light and flexible
- * semi-removable chest protectors
- * front zip

art. # 6599-206 unisex

AIR VEST LIGHT WINTERSPORTS | BIKE | MOTORCYCLE

Sizes: Men: XS - XXL
Women: XS - XL

Features:

- * multilayer Cross Flex back-protector made of adaptive dual-density foam, EN-approved 1621-2
- * extra light
- * optimized silhouette
- * front zip

■ art. # 6597-206 Men
■ art. # 6611-209 Women

PROTECTION ATHLETIC



PROTECTOR INSERT ON THE SIDE

NEW! 25% LIGHTER AND EVEN MORE FLEXIBLE

PROTECTOR INSERT ON THE SIDE



NEW! 25% LIGHTER AND EVEN MORE FLEXIBLE

PRO VEST WINTERSPORTS | BIKE | MOTORCYCLE | EQUESTRIAN

Sizes: Men: S-XXL
Women: XS-XL

- Features:
- * multilayer Cross Flex back-protector made of adaptive dual-density foam, EN-approved 1621-2
 - * protection on the side to safeguard ribs and organs
 - * light and flexible
 - * front zip

art. # 6661-202 Men

PRO VEST WINTERSPORTS | BIKE | MOTORCYCLE | EQUESTRIAN

Sizes: Men: S-XXL
Women: XS-XL

- Features:
- * multilayer Cross Flex back-protector made of adaptive dual-density foam, EN-approved 1621-2
 - * protection on the side to safeguard ribs and organs
 - * light and flexible
 - * front zip

art. # 6662-240 Women

PROTECTION CASUAL



HOODY
made of super-soft fleece,
snugly & warm



CROSS FLEX PROTECTOR
the safest protection –
EN 1621-2



**KANGAROO
POCKETS**



Bond Material



Sonic Material



Bond Material



Sonic Material

FULL ZIP HOODY WINTERSPORTS | EQUESTRIAN

Sizes: Men: XS-XXL
Women: XXS-XL

Features:

- * multilayer Cross FLEX back-protector, made of adaptive dual-density foam, EN-approved 1621-2
- * made of comfortably fitting fleece
- * 4-way stretch- material
- * hood with draw-string
- * integrated kidney-belt, adjustable with velcro fastener
- * front zip

art. # 6353-207 Men
art. # 6356-240 Women

FULL ZIP SWEATER WINTERSPORTS | EQUESTRIAN

Sizes: Men: XS-XXL
Women: XXS-XL

Features:

- * multilayer Cross FLEX back-protector, made of adaptive dual-density foam, EN-approved 1621-2
- * made of comfortably fitting fleece
- * 4-way stretch- material
- * integrated kidney-belt, adjustable with velcro fastener
- * front zip

art. # 6354-207 Men art. # 6357-240 Women
art. # 6354-202 Men art. # 6357-209 Women

PROTECTION CASUAL



REMOVEABLE HOOD
fully customizable with
draw-string and rubber cord



**BEST COLD & WIND
PROTECTION**
due to thermo-isolating,
extra light technical
materials



**INTEGRATED
KIDNEY-BELT**
adjustable with
velcro-fastener



**BREATHABLE,
WIND- & WATERPROOF**
due to stretch laminate



NEW! 25% LIGHTER AND EVEN
MORE FLEXIBLE

THERMOVEST WINTERSPORTS | EQUESTRIAN

Sizes: Men: S-XXL
Women: XS-L

Features:

- * multilayer Cross 6.0 back-protector, made of adaptive dual-density foam, EN-approved 1621-2
- * innovative material-mix: extra-light light shell material combined with smart breathable thermo-padding
- * removeable hood stormproof
- * concealed chest pocket with zip & 2 concealed side-pockets

art. # 6351-207 Men
art. # 6352-209 Women

SOFTSHELL VEST WINTERSPORTS | BIKE | MOTORCYCLE | EQUESTRIAN

Sizes: XS-XL

Features:

- * multilayer Cross 6.0 back-protector, made of adaptive dual-density foam, EN-approved 1621-2
- * chest pocket
- * inside pockets with zip
- * Nutrition pocket
- * reflective prints
- * front zip

art. # 6605-206 Men
art. # 6606-209 Women



BALLISTIC PRO JUNIOR

BECAUSE ONLY THE BEST PROTECTION IS GOOD ENOUGH FOR OUR KIDS

We exclusively provide 360° all around protection. At the same time the automatic width adjustment ensures unlimited freedom of movement.



BALLISTIC FLEX FIT PRO JUNIOR WINTERSPORTS | BIKE | MOTORCYCLE | EQUESTRIAN

Sizes: 116 - 152

Features:

- * multilayer Cross 6.0 back-protector, made of adaptive dual-density foam, EN-approved 1621-2 level 2
- * 360° all around protection - top protection values
- * automatic width adjustment
- * extremely lightweight & breathable protector
- * best safety values
- * with front zipper - easier to put on and take off
- * unlimited freedom of movement
- * improved ergonomics



ISPO AWARD
GOLD WINNER
2017/2018

art. # 6457-212

PRO SHORT JUNIOR

Sizes: 116 - 152

Features:

- * comfortable foam material for optimal protection of hips
- * slip-proof rubber band at waist and legs

art. # 6133-02

PROTECTION KIDS CORNER



← **ULTIMATE FREEDOM OF MOVEMENT**
for more fun in the snow



BALLISTIC VEST JUNIOR

WINTERSPORTS | EQUESTRIAN

Sizes: 116 - 152

Features:

- ★ multilayer Cross 6.0 Junior back protector made of adaptive dual-density foam, EN-approved 1621-2
- ★ 360° all around protection - top protection values
- ★ light and flexible

■ art. # 6321-208

■ art. # 6321-209



AIR VEST JUNIOR

WINTERSPORTS | BIKE | MOTORCYCLE

Sizes: 116 - 152

Features:

- ★ multilayer Cross 6.0 Junior back protector made of adaptive dual-density foam, EN-approved 1621-2
- ★ top protection values
- ★ light and flexible

■ art. # 6450-18

■ art. # 6452-243



ISPO AWARD WINNER
2016/2017



ISPO AWARD WINNER
2016/2017



NEW! 25% LIGHTER AND EVEN MORE FLEXIBLE

DETACHABLE CHEST STRAP

KIDNEY BELT



BACK PROTECTION
multilayer Cross 6.0 protector for perfect protection



RACE PACK

Sizes: Adult: XXS - XL
Junior: 116 - 152

Features:

- ★ multilayer Cross Flex back-protector made of adaptive dual-density foam, EN-approved 1621-2
- ★ confirms to FIS regulations
- ★ anatomic shaped back part
- ★ new preshaped strap system for best fit - shoulder it like a backpack
- ★ protector insert visible - part of the design concept
- ★ ultimate freedom of movement
- ★ slim kidney belt for perfect fit, adjustable with velcro and push

art. # 6618-208 Adult
art. # 6619-208 Junior

FULL PROTECTOR SLALOM SHIRT LONG

Sizes: Adult: XS - XL
Junior: 116 - 152

Features:

- ★ perfect breathability, comfortable to wear
- ★ multilayer Cross 6.0 back-protector, made of adaptive dual-density foam, EN-approved 1621-2
- ★ perfect protection of back, shoulders, shoulderblades & arms

art. # 6301-208 Adult
art. # 6302-208 Junior

PROTECTOR SLALOM SHIRT

Sizes: Adult: XS - XL
Junior: 116 - 152

Features:

- ★ perfect breathability, comfortable to wear
- ★ body-shape cut
- ★ multilayer protectors made of dual-density foam
- ★ perfect protection of shoulders, shoulderblades and arms
- ★ specially shaped back for perfect combination with the Fis approved Race Pack

art. # 6283-02 Adult
art. # 6284-02 Junior

RACING PROTECTION



MESH MATERIAL →



**BAG FOR
ELBOW PROTECTOR**
the protector can
become so small

FLEX PROTECTOR ELBOW - AIR

WINTERSPORTS | BIKE | MOTORCYCLE

Sizes: S - M - L

Features:

- ★ EN-approved 1621-1 - Level 1
- ★ to slip in
- ★ light and breathable

art. # 6630-206 Adult
art. # 6631-206 Junior

MESH MATERIAL →



**BAG FOR
KNEE PROTECTOR**
the protector can
become so small

FLEX PROTECTOR KNEE - AIR

WINTERSPORTS | BIKE | MOTORCYCLE

Sizes: Adult: S - M - L
Junior: S - M

Features:

- ★ EN-approved 1621-1 - Level 1
- ★ to slip in
- ★ light and breathable

art. # 6632-206 Adult
art. # 6633-206 Junior



PRO SHORT

WINTERSPORTS | BIKE

Sizes: unisex, XXS - XXL

Features:

- ★ comfortable foam material for optimal protection of coccyx, thighs and hips
- ★ sporty look

art. # 6355-212 unisex



STORMHOOD

Sizes: Junior/Adult
Features:
 * BC-Flex with rapid-dry function
 * 4-way stretch – extra elastic
 * perfect to be worn under helmet

art. # 6210-02 Adult
 art. # 6211-02 Junior



ARCTIC STORMHOOD

Sizes: unisex
Features:
 * BC-Flex with rapid-dry function
 * fleece/spandex material
 * warming hood for extra cold temperatures

art. # 6216-02



ARCTIC SCARF

Sizes: unisex
Features:
 * fleece/spandex material
 * multifunctional headgear
 * to be used as scarf, cap or headband

art. # 6209-02



FLEECE MASK

Sizes: Junior/Adult
Features:
 * fleece material
 * fully adjustable with velcro fastener

art. # 6212-02 Adult
 art. # 6213-02 Junior



NEOPRENE MASK

Sizes: Junior/Adult
Features:
 * neoprene material
 * fully adjustable with velcro fastener

art. # 694-02 Adult
 art. # 603-02 Junior



KNITTED NOSTALGIC CAP

Sizes: unisex
Features:
 * 100% soft acrylic
 * retro look – still a sales hit

□ art. # 602-1 white/red
 ■ art. # 602-2 black/red



MERINO WOOL

ALPINE MERINO

Sizes: XS - XXL
Features:
 * seamless: wind- & waterproof
 * breathable 4-layer material concept
 * non slip & abrasion-resistant palm
 * merino wool mix inside lining for optimal heat insulation

art. # 401-02



MERINO WOOL

FREERIDE LIGHT

Sizes: XS - XXL
Features:
 * seamless: wind- & waterproof
 * breathable 4-layer material concept
 * palm with abrasion-resistant kevlar-material
 * merino wool mix inside lining for optimal heat insulation

art. # 447-02



BC FLEX
 outside lining

TOURING BC FLEX

Sizes: XS - XXL
Features:
 * seamless: wind- & waterproof
 * 3-layer material concept
 * odour-neutralizing & breathable
 * humidity-absorbing
 * palm with non-slip material
 * comfortable soft brushed BC-Flex inside-lining
 * extra light & thin material

art. # 410-02



TERRY CLOTH
 lining in- & outside

TOURING FROTTEE

Sizes: XS - XL
Features:
 * seamless: wind- & waterproof
 * 3-layer material concept
 * breathable & humidity-absorbing
 * palm, with non-slip reinforced
 * extra warm terry cloth lining for cold winter tours
 * middle- and ring finger made of soft-shell material

art. # 411-03



RACING GLOVE

Sizes: XS - XL
Features:
 * genuine leather
 * special heat insulation
 * knuckles protection out of carbon (only Adult)
 * shock absorbing foam on fingers, thumb and back of the hand

art. # 6501-02 Adult
 art. # 6620-02 Junior



RACING LOBSTER

Sizes: XS - XL
Features:
 * genuine leather
 * special heat insulation
 * knuckles protection out of carbon (only Adult)
 * shock absorbing foam on fingers, thumb and back of the hand

art. # 6502-02 Adult
 art. # 6621-02 Junior

COVER



THERMO MITTENS

Sizes: S & L
Features:
 * neoprene mitten to wear over a 5-finger glove
 * optimal heat insulation in case of low temperatures
 * multifunctional usage

art. # 405-02



LEATHER GLOVES

Sizes: S [6,5]
 M [7,5]
 L [9]
 XL [10]
Features:
 * genuine leather
 * extra warm

art. # 441-02



BIKE & MOTORCYCLE

WHY DO YOU NEED A BACK PROTECTOR?

Especially in the extreme application areas of motorcycling and biking, not only an optimally guarding protector is crucial, but also a pleasant wearing comfort and good ventilation. No other fulfils the highest protection values and is at the same time as comfortable to wear as a Komperdell protector!



PERFECT COMBINATION OF SAFETY AND COMFORT



TOP RESIDUAL
FORCE VALUES
5,93_{EN}

100%
BREATHABLE

MAXIMUM
BREATHABILITY
due to generous perforation



UNLIMITED
MULTI IMPACT
CAPABILITY

0
GRAM
EXTRA
WEIGHT

PERFECTLY
THOUGHT OUT
protector integrated
directly into the
backpack

INTEGRATED
STORM JACKET

1 BALLISTIC SET EN 1621-2 - LEVEL 2

Perfectly thought out – our 2-in-1 strap-on protector. The multi-layered back protector and the removable chest protector ensures maximum safety while the slim design guarantees breathability and ventilation, especially in summer.

2 MTB-PRO PROTECTORPACK EN 1621-2 - LEVEL 2

The MTB-Pro Protectorpack is the ideal companion for long mountain bike tours thanks to sufficient storage space and many well thought-out details. The back protector is light and flexible, and thanks to the multiple layers of adaptive dual-density foam, it achieves the highest protection values.

PROTECTION DOWNHILL-ENDURO



SEMI-REMOVABLE CHEST PROTECTORS

certified according to
the motorcycle
standard EN 1621-3

REMOVABLE
SHOULDER PROTECTORS

PROTECTOR INSERT
ON THE SIDE



NEW! 25% LIGHTER AND EVEN
MORE FLEXIBLE

EXTRA STRONG, ELASTIC
RUBBER BINDING
to ensure a secure hold

NUTRITION POCKET
at the lower back

ARMOUR JACKET

Sizes: unisex, XS - XL

Features:

- * multilayer Cross Flex back-protector made of adaptive dual-density foam, EN-approved 1621-2
- * light and flexible
- * protection on the side to safeguard ribs and organs
- * removable shoulder protectors
- * semi-removable chest protectors
- * Nutrition pocket at the lower back
- * front zip

art. # 6601-206 unisex



SEMI-REMOVABLE CHEST PROTECTORS

certified according to
the motorcycle
standard EN 1621-3

PROTECTOR INSERT
ON THE SIDE



NEW! 25% LIGHTER AND EVEN
MORE FLEXIBLE

ARMOUR VEST

WINTERSPORTS | BIKE | MOTORCYCLE

Sizes: unisex, XS - XXL

Features:

- * multilayer Cross Flex back-protector made of adaptive dual-density foam, EN-approved 1621-2
- * light and flexible
- * protection on the side to safeguard ribs and organs
- * semi-removable chest protectors
- * front zip

art. # 6600-206 unisex

PROTECTION MOUNTAINBIKE



AIR VEST

PERFECT COMBINATION OF SAFETY AND COMFORT

The Air Vest Models are light and flexible, and therefore hardly noticeable while wearing. A real classic for the slopes due to ultimate mobility and good ventilation.

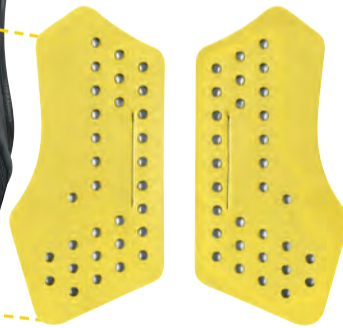

NEW! 25% LIGHTER AND EVEN MORE FLEXIBLE

SEMI-REMOVABLE CHEST PROTECTORS
certified according to the motorcycle standard EN 1621-3

EXTRA STRONG, ELASTIC RUBBER BINDING
to ensure a secure hold



NEW! 25% LIGHTER AND EVEN MORE FLEXIBLE



AIR VEST + WINTERSPORTS | BIKE

Sizes: unisex, XS - XL

Features:

- * multilayer Cross Flex back-protector made of adaptive dual-density foam, EN-approved 1621-2
- * light and flexible
- * semi-removable chest protectors
- * front zip

art. # 6599-206 unisex

AIR VEST LIGHT WINTERSPORTS | BIKE | MOTORCYCLE

Sizes: Men: XS - XXL
Women: XS - XL

Features:

- * multilayer Cross Flex back-protector made of adaptive dual-density foam, EN-approved 1621-2
- * extra light
- * optimized silhouette
- * front zip

art. # 6597-206 Men
art. # 6611-209 Women

PROTECTION DOWNHILL-ENDURO



PRO SHORT WINTERSPORTS | BIKE

Sizes: unisex, XXS-XXL

Features:

- ★ comfortable foam material for optimal protection of coccyx, thighs and hips
- ★ sporty look

art. # 6355-2126 unisex



1 SYSTEM = 2 BRILLIANT PRODUCTS



ADAPTIVE
CHEST PROTECTION

NEW! 25% LIGHTER AND EVEN
MORE FLEXIBLE

2-IN-1 STRAP-ON PROTECTOR

exchangeable strap system
turns your strap-on protector into a
complete 360° protector



NUTRITION POCKET
at the lower back

NEW! 25% LIGHTER AND EVEN
MORE FLEXIBLE



BALLISTIC SET WINTERSPORTS | BIKE | MOTORCYCLE

Sizes: XS - XL

Features:

- ★ multilayer Cross Flex Center-Back-protector made of adaptive dual-density foam, EN-approved 1621-2
- ★ ultimate mobility
- ★ removable chest protection, strap attached separately
- ★ slim kidney-belt for the perfect fit, adjustable with velcro fastener
- ★ Nutrition pocket at the lower back

art. # 6602-206 Men

art. # 6616-209 Women

BALLISTIC PACK WINTERSPORTS | BIKE | MOTORCYCLE

Sizes: XS - XL

Features:

- ★ multilayer Cross Flex Center-Back-protector made of adaptive dual-density foam, EN-approved 1621-2
- ★ ultimate mobility
- ★ removable strap
- ★ slim kidney-belt for the perfect fit, adjustable with velcro fastener
- ★ Nutrition pocket at the lower back

art. # 6610-206 Men

art. # 6617-209 Women

PROTECTION URBAN



CROSS FLEX PROTEKTOR
the safest protector – EN 1621-2



OPTIONAL WITH STORM JACKET



INTEGRATED STORM JACKET



BREATHABLE, WIND- & WATERPROOF
due to stretch laminate

NEW! 25% LIGHTER AND EVEN MORE FLEXIBLE

Sizes: XS - XL
art. # 6350-02

NEW! 25% LIGHTER AND EVEN MORE FLEXIBLE

URBAN SOFTSHELL JACKET

Sizes: XS - XL

Features:

- * multilayer Cross 6.0 back-protector, made of adaptive dual-density foam, EN-approved 1621-2
- * removable shoulder and elbow protectors
- * inside pockets with zip
- * chest pocket
- * Nutrition pocket
- * reflective prints
- * front zip

art. # 6603-206 Men
art. # 6604-209 Women

URBAN SOFTSHELL VEST

Sizes: XS - XL

Features:

- * multilayer Cross 6.0 back-protector, made of adaptive dual-density foam, EN-approved 1621-2
- * chest pocket
- * inside pockets with zip
- * Nutrition pocket
- * reflective prints
- * front zip

art. # 6628-206 Men
art. # 6629-209 Women

PROTECTION MOUNTAINBIKE



MESH MATERIAL



ESPECIALLY SOFT AND
7 MM THIN PROTECTOR
EN 1621-1 LEVEL 1

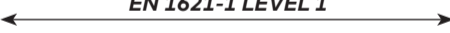

BAG FOR
ELBOW PROTECTOR
the protector can
become so small

FLEX PROTECTOR ELBOW - AIR

Sizes: Adult: S - M - L
Junior: S - M - L

- Features:
- ★ EN-approved 1621-1 - Level 1
 - ★ to slip in
 - ★ light and breathable

art. # 6630-206 Adult
art. # 6631-206 Junior

MESH MATERIAL



BAG FOR
KNEE PROTECTOR
the protector can
become so small

FLEX PROTECTOR KNEE - AIR

Sizes: Adult: S - M - L
Junior: S - M

- Features:
- ★ EN-approved 1621-1 - Level 1
 - ★ to slip in
 - ★ light and breathable

art. # 6632-206 Adult
art. # 6633-206 Junior

PROTECTION MOUNTAINBIKE



ADDITIONAL
PROTECTORS ON
THE SIDES



ANTI-SLIP RUBBER
with additional Velcro
for adjustment



ESPECIALLY SOFT AND
9 MM THIN PROTECTOR
EN 1621-1 LEVEL 2

ADDITIONAL
PROTECTORS ON
THE SIDES



ANTI-SLIP RUBBER
with additional Velcro
for adjustment

CAN EASILY BE WORN
OVER TROUSERS

ADDITIONAL PROTECTORS
ON THE SHIN

FLEX PROTECTOR KNEE - GUARDPLUS

Sizes: S - M - L

- Features:
- ★ EN-approved 1621-1 - Level 2
 - ★ to slip in
 - ★ additional protectors on the sides
 - ★ extra grip due to anti-slip rubber

art. # 6634-206

FLEX PROTECTOR KNEE - GUARDPRO

Sizes: Adult: S - M - L
Junior: S - M - L

- Features:
- ★ EN-approved 1621-1 - Level 2
 - ★ individually adaptable
 - ★ additional protectors on the sides and the shin
 - ★ extra grip due to anti-slip rubber

art. # 6635-206 Adult
art. # 6636-206 Junior

PROTECTION URBAN



URBAN

PERFECTLY PROTECTED IN ANY WEATHER

With our Urban Pack you are perfectly protected, regardless if the sun is shining or it is raining – with the integrated waterproof storm jacket you are prepared for any kind of weather.



HELMET HOLDER

DRINK BOTTLE POCKET

INTEGRATED STORM JACKET
instead of a conventional raincover



URBAN PROTECTORPACK 2.0

Sizes: unisex
XS - XL

- Features:
- ★ multilayer Cross 7.1 FB back protector made of adaptive dual-density foam, EN-approved 1621-2
 - ★ optional with waterproof storm jacket
 - ★ lightweight and flexible
 - ★ highest safety values
 - ★ slim kidney belt for perfect fit
 - ★ washable

art. # 6637-206

URBAN PROTECTORPACK

Sizes: unisex
XS - XL

- Features:
- ★ multilayer Cross 7.1 FB back protector made of adaptive dual-density foam, EN-approved 1621-2
 - ★ waterproof storm jacket included
 - ★ lightweight and flexible
 - ★ highest safety values
 - ★ slim kidney belt for perfect fit
 - ★ washable

art. # 6346-02



NOTEBOOK CASE

Sizes: S - M - L

art. # 6349-02

PROTECTION MOUNTAINBIKE



MOUNTAINBIKE

MAXIMUM PROTECTION WITHOUT ADDITIONAL WEIGHT

While others work with a separate protector-plate, we are the only manufacturer who constructs the entire back section. Ergonomically perfectly fitting back protector with sufficient storage space and clever details.



MTB-PRO PROTECTORPACK 2.0

Sizes: unisex
S - M - L

Features:

- * multilayer Cross 7.1 FB back protector made of adaptive dual-density foam, EN-approved 1621-2
- * Raincover included
- * lightweight and flexible
- * highest safety values
- * slim kidney belt for perfect fit
- * washable

art. # 6342-206

Optional:

- * BATTERYPACK
padded pack for spare battery
- * NOTEBOOKCASE S - M - L
padded pack for Pads/Notebooks
- * WATER RESERVOIR 2L

Inclusive:

- * STORM JACKET XS - XL
waterproof and breathable jacket

art. # 6348-02

art. # 6349-02
art. # 6371-10

art. # 6350-02



STORM JACKET

Sizes: XS - XL

art. # 6350-02

PROTECTION MOUNTAINBIKE



MTB-PRO PROTECTORPACK

Sizes: unisex
black/green; S - M - L
black/blue; M - L
black/malbec; S - M

Features:
 * multilayer Cross 7.1 FB back protector made of adaptive dual-density foam, EN-approved 1621-2
 * lightweight and flexible
 * highest safety values
 * slim kidney belt for perfect fit
 * washable

Optional:
 * BATTERYPACK
 padded pack for spare battery
 * NOTEBOOKCASE S - M - L
 padded pack for Pads/Notebooks
 * STORM JACKET XS - XL
 waterproof and breathable jacket

Inclusive:
 * WATER RESERVOIR 2L
 * RAINCOVER

art. # 6348-02

art. # 6349-02

art. # 6350-02



■ art. # 6340-230

■ art. # 6338-213

■ art. # 6339-04



EQUESTRIAN

WHY DO YOU NEED A BACK PROTECTOR?

The most common insures are caused by horse kicks or rotational falls, where the horse lands on the rider. The Komperdell protector can help in both cases, as 93% of the impact energy is absorbed. Therefore, a helmet as well as a back protector should be a part of every rider's basic essential.



3 TYPES OF PROTECTORS FOR MAXIMUM SAFETY IN EQUITATION



1 SAFETY VEST FRONTZIP EN 13158:2018 – LEVEL 3



Our safest equestrian protector with 360° protection and EN 13158:2018 - Level 3 certification. The ergonomic cut and the especially soft, flexible protector body ensure maximum comfort with best protection values. Perfect for cross-country riding and approved for eventing.

2 BALLISTIC FLEX FIT EN 1621-2 – LEVEL 2



In addition to the multi-layered back protector, the vest offers protection zones in the front and rib areas and is therefore the ideal protector for daily training. The automatic width adjustment ensures almost complete all-round protection with the best wearing comfort, as the vest automatically adapts to the rider's shape.

3 CASUAL PROTECTION EN 1621-2 – LEVEL 2

The casual line is the perfect alternative for daily training and work with the horse, as the protector is integrated directly into the garment, eliminating one layer of functional clothing. Absolute lightness and breathability guaranteed!

SAFETY VEST LEVEL 3



EN 13158:2018
LEVEL 3

SAFETY VEST

360° PERFECT SAFETY WITH OUR LEVEL 3 VEST

Our safety vest providing 360° protection is amazingly comfortable. Due to its special ergonomic cut it perfectly contours to your individual body shape. The multi-layer construction and the especially soft foam guarantee a perfectly ergonomic fit.



extended perforation
in the front and back



SAFETY VEST REGULAR-FIT FRONTZIP

Sizes: S - XXL

Features:

- * EN approved 13158:2018 – level 3
- * 360° all around protection
- * further improved ergonomic body shape construction
- * extremely lightweight & flexible protector
- * best safety values
- * with front zipper – easier to put on and take off
- * integrated width regulation
- * easy to wash and take care of
- * design made in Austria
- * transport protection sleeve included

art. # 6296-02 unisex



SAFETY VEST SLIM-FIT FRONTZIP

Sizes: XS - L

Features:

- * EN approved 13158:2018 – level 3
- * 360° all around protection
- * further improved ergonomic body shape construction
- * extremely lightweight & flexible protector
- * best safety values
- * with front zipper – easier to put on and take off
- * integrated width regulation
- * easy to wash and take care of
- * design made in Austria
- * transport protection sleeve included

art. # 6297-02 unisex



SAFETY VEST JUNIOR FRONTZIP

Sizes: 128 - 164

Features:

- * EN approved 13158:2018 – level 3
- * 360° all around protection
- * further improved ergonomic body shape construction
- * extremely lightweight & flexible protector
- * best safety values
- * with front zipper – easier to put on and take off
- * integrated width regulation
- * easy to wash and take care of
- * design made in Austria
- * transport protection sleeve included

art. # 6298-02 unisex



BALLISTIC LEVEL 2

EN 1621-2 – LEVEL 2

BALLISTIC FLEX FIT

NO PROTECTOR IS SO LEIGHTWEIGHT AND COMFORTABLE TO WEAR

The vest offers almost complete 360° protection and it is significantly more flexible in width. The width of the vest automatically adjusts to the rider's girth when the front zipper is closed.



NEW! 25% LIGHTER AND EVEN MORE FLEXIBLE

automatic width adjustment

CROSS 6.0 PROTECTOR
the safest protection – EN 1621-2 – level 2

NEW! 25% LIGHTER AND EVEN MORE FLEXIBLE

■ black/bordeaux

■ black/steel blue

■ black/silver

BALLISTIC FLEX FIT SLIM

Sizes: XXS - XL

Features:

- * multilayer Cross FLEX back-protector, made of adaptive dual-density foam, EN-approved 1621-2 – level 2
- * back protector with lateral protection area – with generous perforation for maximum breathability
- * automatic width adjustment
- * extremely lightweight & breathable protector
- * best safety values
- * with front zipper – easier to put on and take off
- * unlimited freedom of movement
- * improved ergonomics
- * design made in Austria

- art. # 6447-212 unisex
- art. # 6458-207 unisex
- art. # 6459-229 unisex



BALLISTIC FLEX FIT REGULAR

Sizes: XXS - XXL

Features:

- * multilayer Cross FLEX back-protector, made of adaptive dual-density foam, EN-approved 1621-2 – level 2
- * back protector with lateral protection area – with generous perforation for maximum breathability
- * extremely lightweight & breathable protector
- * automatic width adjustment
- * best safety values
- * with front zipper – easier to put on and take off
- * unlimited freedom of movement
- * improved ergonomics
- * design made in Austria

art. # 6448-212 unisex



BALLISTIC LEVEL 2



EN 1621-2
LEVEL 2

CHAMPION BALLISTIC

40% BETTER PROTECTION – APPROVED WITH LEVEL 2

The almost gapless and additionally reinforced lateral protective zones round off our requirements for the protective performance of a lightweight, slim and particularly comfortable vest, which we would like to offer to children as an alternative to the Level 3 safety vest.



NEW! 25% LIGHTER AND EVEN MORE FLEXIBLE

automatic width adjustment

CROSS 6.0 PROTECTOR
the safest protection – EN 1621-2 - level 2



NEW! 25% LIGHTER AND EVEN MORE FLEXIBLE

ADDITIONAL RIB PROTECTORS perfectly protected



black/bordeaux



black/silver

BALLISTIC VEST CHAMPION WINTERSPORTS | BIKE | EQUESTRIAN

Sizes: 116 - 152

Features:

- * multilayer Cross 6.0 back-protector, made of adaptive dual-density foam, EN-approved 1621-2 level 2
- * back protector with lateral protection area – with generous perforation for maximum breathability
- * automatic width adjustment
- * extremely lightweight & breathable protector
- * best safety values
- * with front zipper – easier to put on and take off
- * unlimited freedom of movement
- * improved ergonomics
- * design made in Austria

art. # 6449-212 unisex
art. # 6460-229 unisex



BALLISTIC LEVEL 1



EN 1621-2 - LEVEL 1

JUNIOR BALLISTIC

ESPECIALLY LIGHT PROTECTION FOR OUR YOUNG RIDERS

The CE-approved back protector features an extra lightweight construction. Together with the slim design it offers 100% freedom of movement and extra comfort.



■ green



■ pink

ADDITIONAL RIB PROTECTORS
perfectly protected



ULTIMATE FREEDOM OF MOVEMENT
for more fun and comfort



BALLISTIC VEST JUNIOR WINTERSPORTS | EQUESTRIAN

Sizes: 116 - 152

Features:

- * multilayer Cross 6.0 back-protector, made of adaptive dual-density foam, EN-approved 1621-2
- * back protector with lateral protection area - with generous perforation for maximum breathability
- * extremely lightweight & breathable protector
- * best safety values
- * with front zipper - easier to put on and take off
- * unlimited freedom of movement
- * improved ergonomics
- * design made in Austria

■ art. # 6321-209
■ art. # 6321-208



ISPO AWARD
GOLD WINNER
2017/2018

EN 1621-2 – LEVEL 2

CASUAL PROTECTION

MAXIMUM SAFETY WITH BEST WEARING COMFORT

A completely new style of protective clothing! Protectors smartly integrated in functional clothing allow decreasing the number of layers resulting in less weight, increased breathability and enhanced freedom of movement.



HOODY
made of super-soft fleece,
snug & warm



CROSS FLEX PROTECTOR
the safest protection –
EN 1621-2



**KANGAROO
POCKETS**



FULL ZIP HOODY SHIRT WINTERSPORTS | EQUESTRIAN

Sizes: Men: XS - XXL
Women: XXS - XL

Features:

- ★ multilayer Cross FLEX back-protector, made of adaptive dual-density foam, EN-approved 1621-2
- ★ made of comfortably fitting fleece
- ★ 4-way stretch- material
- ★ hood with draw-string
- ★ Integrated kidney-belt adjustable with velcro fastener
- ★ front zip

art. # 6353-207 Men
art. # 6356-240 Women

FULL ZIP SWEATER WINTERSPORTS | EQUESTRIAN

Sizes: Men: XS - XXL
Women: XXS - XL

Features:

- ★ multilayer Cross FLEX back-protector, made of adaptive dual-density foam, EN-approved 1621-2
- ★ made of comfortably fitting fleece
- ★ 4-way stretch- material
- ★ Integrated kidney-belt adjustable with velcro fastener
- ★ front zip

art. # 6354-207 Men art. # 6357-240 Women
art. # 6354-202 Men art. # 6357-209 Women

EN 1621-2 – LEVEL 2

CASUAL PROTECTION

WITH INTELLIGENT COLD PROTECTION

The hybrid construction vest is made of extra lightweight, insulating materials and offers reliable protection from wind and cold.



CONCEALED SIDE BREAST POCKETS
with zip

4-WAY STRETCH LIGHT SHELL MATERIAL
for comfort

REMOVEABLE HOOD
fully customizable with draw-string and rubber cord

CONCEALED SIDE-POCKETS
with zip

INTEGRATED KIDNEY-BELT
adjustable with velcro-fastener

BEST COLD & WIND PROTECTION
due to thermo-insulating, extra light technical materials

THERMOVEST WINTERSPORTS | EQUESTRIAN

Sizes: Men: S - XXL
Women: XS - XL

Features:

- * multilayer Cross 6.0 back-protector, made of adaptive dual-density foam, EN-approved 1621-2
- * innovative material-mix: extra-light light shell material combined with smart breathable thermo-padding
- * removeable hood stormproof
- * concealed chest pocket with zip & 2 concealed side-pockets

♂ art. # 6351-207 Men
♀ art. # 6352-209 Women



TREKKING

20% LIGHTER POLES AND THE STRONGEST LOCKING MECHANISM ON THE MARKET

We are pioneers in carbon trekking poles and have dedicated ourselves like no other brand to a lightweight construction without losing reliability and stability.



INCREDIBLE LIGHTWEIGHT

While other brands buy carbon tubes of the shelf, we have been developing and manufacturing our carbon shafts by ourselves for more than 25 years. When we develop a new model it starts with the development of the shaft itself.



THE STRONGEST LOCKING MECHANISM

We are the only ones who produce a locking system entirely made of aluminum. This Powerlock 3.0 guarantees absolutely safety with a holding power of up to 200 kg and is not affected by any weather conditions at all.



UNIQUE FXP FOLDING SYSTEM

The first and only self-deploying mechanism on the market. A solid mechanical connection that guarantees safety on all activities. The self-deploying feature is a game-changer and makes the handling of the pole as fast and easy as possible.



OutDoor
by ISPO
Outstanding Outdoor
Gold Winner 2019
an ISPO Award

FXP CARBON

MOUNTAINEERING WAS NEVER EASIER!

Handling the FXP is as easy as it can be. The packed pole is held together by a Velcro strap and once opened, it unfolds completely by itself. This is not only easy, it also saves time and creates a unique experience.

CARBON .FXP TEAM VARIO GREEN

Sizes: packed size: 41 cm
115 - 135 cm

Weight: 216g

Features:

- ★ Trail Pro 245 cork grip
- ★ Trail Click-In 2.1 strap
- ★ 4-sections: Carbon Ultralight, Ø 18/16 mm
- ★ Powerlock 3.0 locking mechanism
- ★ FXP folding mechanism
- ★ Trailstick carbide tip

OutDoor by ISPO
Outstanding Outdoor
Gold Winner 2019
an ISPO Award

art. # 194 23 66-48

CARBON .FXP TEAM VARIO PINK

Sizes: packed size: 38 cm
105 - 125 cm

Weight: 204g

Features:

- ★ Trail Pro 245 cork grip
- ★ Trail Click-In 2.1 strap
- ★ 4-sections: Carbon Ultralight, Ø 18/16 mm
- ★ Powerlock 3.0 locking mechanism
- ★ FXP folding mechanism
- ★ Trailstick carbide tip

OutDoor by ISPO
Outstanding Outdoor
Gold Winner 2019
an ISPO Award

art. # 194 23 67-14

CARBON .FXP TEAM GREEN FOLDABLE

Sizes: 105/115/125/135 cm

Weight: 209g (115 cm)

Features:

- ★ Trail Pro 245 cork grip
- ★ Trail Click-In 2.1 strap
- ★ 3-sections: Carbon Ultralight, Ø 16 mm
- ★ FXP folding mechanism
- ★ Trailstick carbide tip

OutDoor by ISPO
Outstanding Outdoor
Gold Winner 2019
an ISPO Award

art. # 194 23 59-48

CARBON .FXP TEAM PINK FOLDABLE

Sizes: 105/115/125/135 cm

Weight: 209g (115 cm)

Features:

- ★ Trail Pro 245 cork grip
- ★ Trail Click-In 2.1 strap
- ★ 3-sections: Carbon Ultralight, Ø 16 mm
- ★ FXP folding mechanism
- ★ Trailstick carbide tip

OutDoor by ISPO
Outstanding Outdoor
Gold Winner 2019
an ISPO Award

art. # 194 23 60-14



CARBON .FXP TRAIL CLICK IN

Sizes: 105/115/125/135 cm
Weight: 220g (115cm)

Features:

- * Trail Pro 245 Foam grip
- * Trail Click-In 2.1 strap
- * 3-sections: Carbon Composite, Ø 16mm
- * FXP folding mechanism
- * Trailstick carbide tip

OutDoor by ISPO
art. # 194 23 50-10

CARBON .FXP TRAIL

Sizes: 105/115/125/135 cm
Weight: 210g (115cm)

Features:

- * Trail Pro 245 Full Foam grip
- * Comfort Padded strap
- * 3-sections: Carbon Composite, Ø 16mm
- * FXP folding mechanism
- * Trailstick carbide tip

OutDoor by ISPO
art. # 194 23 51-10



CARBON FXP.4 SUMMIT VARIO

Sizes: packed size: 41 cm
adjustable from 115 - 135 cm

Weight: 249g

Features:

- * Trek Pro cork 245 grip
- * AIR Padded strap
- * 4-sections: Carbon, Ø 18/16mm
- * Powerlock 3.0 mechanism
- * FXP folding mechanism
- * FXP-UL VARIO basket
- * tungsten/carbide flex tip

OutDoor by SPO

art. # 194 23 63-10

CARBON FXP.4 SUMMIT VARIO COMPACT

Sizes: packed size: 38 cm
adjustable from 105 - 125 cm

Weight: 238g

Features:

- * Trek Pro cork 245 grip
- * AIR Padded strap
- * 4-sections: Carbon, Ø 18/16mm
- * Powerlock 3.0 mechanism
- * FXP folding mechanism
- * FXP-UL VARIO basket
- * tungsten/carbide flex tip

OutDoor by SPO

art. # 194 23 64-10

CARBON FXP.4 APPROACH VARIO

Sizes: packed size: 41 cm
adjustable from 115 - 135 cm

Weight: 260g

Features:

- * Trek Pro Foam 245 grip
- * Comfort Padded strap
- * 4-sections: Aluminum 7075-T6, Ø 18mm
- * Carbon, Ø 16mm
- * Powerlock 3.0 mechanism
- * FXP folding mechanism
- * FXP-UL VARIO basket
- * tungsten/carbide flex tip

OutDoor by SPO

art. # 194 23 56-10

CARBON FXP.4 APPROACH VARIO COMPACT

Sizes: packed size: 38 cm
adjustable from 105 - 125 cm

Weight: 243g

Features:

- * Trek Pro Foam 245 grip
- * Comfort Padded strap
- * 4-sections: Aluminum 7075-T6, Ø 18mm
- * Carbon, Ø 16mm
- * Powerlock 3.0 mechanism
- * FXP folding mechanism
- * FXP-UL VARIO basket
- * tungsten/carbide flex tip

OutDoor by SPO

art. # 194 23 57-10



3 YEAR SERVICE
NO QUESTIONS ASKED

**CALIMA
CARBON CLOUD**

Sizes: packed size: 57 cm
adjustable from 90 - 120 cm

Weight: 181 g

Features:

- * Trek Pro Foam 280 cork grip
- * AIR Padded strap
- * 3-sections:
top part: Carbon Cloud, Ø 18 mm
middle part: Carbon Cloud, Ø 16 mm
lower part: Carbon Cloud, Ø 14 mm
- * Powerlock 3.0 mechanism
- * Mini UL Vario basket
- * tungsten/carbide flex tip

ISPO Award 2022 Winner

CHALLENGE SERVICER
Leading 2022

COUNTRYFILE favourite

art. # 175 23 58-10

3 YEAR SERVICE
NO QUESTIONS ASKED

**BOREA
CARBON PRO**

Sizes: packed size: 57 cm
adjustable from 90 - 120 cm

Weight: 216 g

Features:

- * Trek Pro Foam 280 cork grip
- * AIR Padded strap
- * 3-sections:
top part: Carbon, Ø 18 mm
middle part: Carbon, Ø 16 mm
lower part: Titanal .HF, Ø 14 mm
- * Powerlock 3.0 mechanism
- * Mini UL Vario basket
- * tungsten/carbide flex tip

art. # 175 23 59-10



POWERLOCK 3.0
highly rigid, anodized aluminum for maximum holding power!

3 YEAR SERVICE
NO QUESTIONS ASKED

**TRAMONTANA
TI**

Sizes: packed size: 57 cm
adjustable from 90 - 120 cm

Weight: 221 g

Features:

- * Trek Pro 280 Foam grip
- * Comfort Padded strap
- * 3-sections:
top part: Aluminum 7075-T6, Ø 18 mm
middle part: Aluminum 7075-T6, Ø 16 mm
lower part: Aluminum 7075-T6, Ø 14 mm
- * Powerlock 3.0 mechanism
- * Mini UL Vario basket
- * tungsten/carbide flex tip

art. # 174 23 56-10

CARBON C3 CLOUD



The lightest poles on the market!





CARBON .C3 PRO

Sizes: packed size: 67 cm
adjustable from 105 - 140 cm

Weight: 219g

Features:

- * Trek Pro 280 Foam grip
- * Comfort Padded strap
- * 3-sections:
 - top part: Carbon, Ø 18 mm
 - middle part: Carbon, Ø 16 mm
 - lower part: Titanal.HF, Ø 14 mm
- * Powerlock 3.0 mechanism
- * Mini UL Vario basket
- * tungsten/carbide flex tip

art. # 175 23 60-10



CARBON .C3 PRO COMPACT

Sizes: packed size: 57 cm
adjustable from 90 - 120 cm

Weight: 199g

Features:

- * Trek Pro 280 Foam grip
- * Comfort Padded strap
- * 3-sections:
 - top part: Carbon, Ø 18 mm
 - middle part: Carbon, Ø 16 mm
 - lower part: Titanal.HF, Ø 14 mm
- * Powerlock 3.0 mechanism
- * Mini UL Vario basket
- * tungsten/carbide flex tip

art. # 175 23 61-10



CARBON COMPOSITE .C3

Sizes: packed size: 67 cm
adjustable from 105 - 140 cm

Weight: 212 g

Features:

- * Trek Pro 150 Foam grip
- * Comfort Padded strap
- * 3-sections:
 - top part: Carbon, Ø 18 mm
 - middle part: Carbon, Ø 16 mm
 - lower part: Titanal.HF, Ø 14 mm
- * Powerlock 3.0 mechanism
- * Mini UL Vario basket
- * tungsten/carbide flex tip

art. # 175 23 70-10



CARBON COMPOSITE .C3 COMPACT

Sizes: packed size: 57 cm
adjustable from 90 - 120 cm

Weight: 193 g

Features:

- * Trek Pro 150 Foam grip
- * Comfort Padded strap
- * 3-sections:
 - top part: Carbon, Ø 18 mm
 - middle part: Carbon, Ø 16 mm
 - lower part: Titanal hanism
- * Powerlock 3.0 mechanism
- * Mini UL Vario basket
- * tungsten/carbide flex tip

art. # 175 23 71-10

TITANAL EXPLORER



3 YEAR SERVICE
NO QUESTIONS ASKED

LONG GRIP ZONE →

65 cm

EXPLORER CONTOUR CORK

Sizes: packed size: 65 cm
adjustable from 105 - 140 cm

Weight: 242 g

Features:

- * Trek Pro Foam 280 cork grip
- * Comfort Padded strap
- * Aluminum 7075-T6, 3-sections Ø 18/16/14 mm
- * Powerlock 3.0 mechanism
- * Mini UL Vario basket
- * tungsten/carbide flex tip

TIPPREIS KOMPERDELL 100 Preis-Tipp

LAND FOR BERGE

art. # 174 23 18-10

3 YEAR SERVICE
NO QUESTIONS ASKED

LONG GRIP ZONE →

57 cm

EXPLORER COMPACT CORK

Sizes: packed size: 57 cm
adjustable from 90 - 120 cm

Weight: 228 g

Features:

- * Trek Pro Foam 280 cork grip
- * Comfort Padded strap
- * Aluminum 7075-T6, 3-sections Ø 18/16/14 mm
- * Powerlock 3.0 mechanism
- * Mini UL Vario basket
- * tungsten/carbide flex tip

TIPPREIS KOMPERDELL 100 Preis-Tipp

LAND FOR BERGE

art. # 174 23 16-10

3 YEAR SERVICE
NO QUESTIONS ASKED

LONG GRIP ZONE →

65 cm

EXPLORER CONTOUR POWERLOCK

Sizes: packed size: 65 cm
adjustable from 105 - 140 cm

Weight: 237 g

Features:

- * Trek Pro Foam 280 grip
- * Comfort Padded strap
- * Aluminum 7075-T6, 3-sections Ø 18/16/14 mm
- * Powerlock 3.0 mechanism
- * Mini UL Vario basket
- * tungsten/carbide flex tip

TIPPREIS KOMPERDELL 100 Preis-Tipp

LAND FOR BERGE

art. # 174 23 14-10

3 YEAR SERVICE
NO QUESTIONS ASKED

LONG GRIP ZONE →

57 cm

EXPLORER COMPACT POWERLOCK

Sizes: packed size: 57 cm
adjustable from 90 - 120 cm

Weight: 224 g

Features:

- * Trek Pro Foam 280 grip
- * Comfort Padded strap
- * Aluminum 7075-T6, 3-sections Ø 18/16/14 mm
- * Powerlock 3.0 mechanism
- * Mini UL Vario basket
- * tungsten/carbide flex tip

TIPPREIS KOMPERDELL 100 Preis-Tipp

LAND FOR BERGE

art. # 174 23 15-10



THOMAS DRESSEN
ALPINE SKIER - GERMANY
WORLD CUP WINNER

TREKKING ALUMINUM





3 YEAR SERVICE

68 cm

ANTISHOCK TIP
high-quality steel spring
absorbs vibrations

**SHOCKMASTER
CORK POWERLOCK**

Sizes: packed size: 68 cm
adjustable from 105 - 140 cm

Weight: 298 g

Features:

- * Tour 170 cork 1K grip
- * padded trekking strap
- * Aluminum 7075-T6, 3-sections Ø 18/16/14 mm
- * Powerlock 3.0 mechanism
- * Mini UL Vario basket
- * Shocktip

art. # 174 23 22-10



3 YEAR SERVICE

63 cm
5 cm smaller
packed size

**SHOCKMASTER CORK
POWERLOCK COMPACT**

Sizes: packed size: 63 cm
adjustable from 90 - 120 cm

Weight: 277 g

Features:

- * Tour 170 cork 1K grip
- * padded trekking strap
- * Aluminum 7075-T6, 3-sections Ø 18/16/14 mm
- * Powerlock 3.0 mechanism
- * Mini UL Vario basket
- * Shocktip

art. # 174 23 23-10



3 YEAR SERVICE

64 cm

POWERLOCK 3.0
highly rigid, anodized
aluminum for max.
holding power!

**RIDGEHIKER
CORK POWERLOCK**

Sizes: packed size: 64 cm
adjustable from 105 - 140 cm

Weight: 275 g

Features:

- * Tour 170 cork 1K grip
- * padded trekking strap
- * Aluminum 7075-T6, 3-sections Ø 18/16/14 mm
- * Powerlock 3.0 mechanism
- * Mini UL Vario basket
- * tungsten/carbide flex tip

art. # 174 23 24-10



3 YEAR SERVICE

57 cm
7 cm smaller
packed size

**RIDGEHIKER CORK
POWERLOCK COMPACT**

Sizes: packed size: 57 cm
adjustable from 90 - 120 cm

Weight: 259 g

Features:

- * Tour 170 cork 1K grip
- * padded trekking strap
- * Aluminum 7075-T6, 3-sections Ø 18/16/14 mm
- * Powerlock 3.0 mechanism
- * Mini UL Vario basket
- * tungsten/carbide flex tip

art. # 174 23 33-10

TREKKING ALUMINUM



3 YEAR SERVICE
NO QUESTIONS ASKED

64 cm

**TREKMASTER
POWERLOCK**

Sizes: packed size: 64 cm
adjustable from 105 - 140 cm

Weight: 251 g

Features:

- * EVA Foam grip
- * system strap XL
- * Aluminum 7075-T6, 3-sections Ø 18/16/14 mm
- * Powerlock 3.0 mechanism
- * Mini UL Vario basket
- * tungsten/carbide flex tip

art. # 174 23 31-10

3 YEAR SERVICE
NO QUESTIONS ASKED

57 cm
7cm smaller
packed size

**TREKMASTER
POWERLOCK COMPACT**

Sizes: packed size: 57 cm
adjustable from 90 - 120 cm

Weight: 231 g

Features:

- * EVA Foam grip
- * system strap XL
- * Aluminum 7075-T6, 3-sections Ø 18/16/14 mm
- * Powerlock 3.0 mechanism
- * Mini UL Vario basket
- * tungsten/carbide flex tip

art. # 174 23 32-10

3 YEAR SERVICE
NO QUESTIONS ASKED

66 cm

HIGHLANDER CORK

Sizes: packed size: 66 cm
adjustable from 105 - 140 cm

Weight: 254 g

Features:

- * Tour 170 cork 1K grip
- * system strap XL
- * Aluminum 7075-T6, 3-sections Ø 18/16/14 mm
- * Twist Lock mechanism
- * Mini UL Vario basket
- * tungsten/carbide flex tip

art. # 174 23 28-10

3 YEAR SERVICE
NO QUESTIONS ASKED

65 cm

WILD RAMBLER

Sizes: packed size: 65 cm
adjustable from 105 - 140 cm

Weight: 240 g

Features:

- * Tour 170 PE 1K grip
- * system strap
- * Aluminum 7075-T6, 3-sections Ø 18/16/14 mm
- * Twist Lock mechanism
- * Mini UL Vario basket
- * steel tip

art. # 174 23 30-10



3 YEAR SERVICE
NO QUESTIONS ASKED

74 cm

POWERLOCK 3.0
highly rigid, anodized aluminum for max. holding power!

PEAK HUNTER JUNIOR POWERLOCK

Size: packed size: 74 cm
adjustable from 90 - 125 cm

Weight: 218 g

Features:

- * Tour cork grip
- * system strap
- * Aluminum 7075-T6, 2-sections Ø 16/14 mm
- * Powerlock 3.0 mechanism
- * Mini UL Vario basket
- * flex steel tip

art. # 164 23 13-10

3 YEAR SERVICE
NO QUESTIONS ASKED

65 cm

TWISTLOCK
made from glassfiber reinforced plastics

TRAILBLAZER KIDS

Size: packed size: 65 cm
adjustable from 80 - 105 cm

Weight: 175 g

Features:

- * Kids Tour cork grip
- * standard strap
- * upper part: Aluminum 7075-T6, Ø 16 mm
- * lower part: Aluminum 5083, Ø 14 mm
- * Twist Lock mechanism
- * Mini UL Vario basket
- * steel tip

art. # 164 23 14-10

TREKKING SINGLE STAFF



CAMERA MOUNT SYSTEM

unscrew the head to mount your camera easily



TRAVEL & WADING STAFF .FXP VARIO

Size: packed size: 45cm
adjustable from 115 - 135cm

Weight: 265g

Features:

- * Full Foam Traveller grip 245 with Camera Mount System
- * Ergo strap
- * 4-sections: Carbon Composite, Ø 18/16mm
- * Powerlock 3.0 mechanism
- * FXP folding mechanism
- * tungsten/carbide flex tip

art. # 196 23 05-10

CAMERA MOUNT SYSTEM

unscrew the head to mount your camera easily



CARBON .FXP WALKING STAFF

Size: packed size: 36cm (95cm)
85 - 105cm
(in 10cm steps)

Weight: 248g

Features:

- * cork walker grip
- * padded Walker strap
- * 3-sections: Carbon Composite, Ø 16/9mm
- * FXP folding mechanism
- * Trailstick carbide tip

art. # 196 23 04-10



CAMERA STAFF

Sizes: packed size: 72cm
adjustable from 115 - 150cm

Weight: 277g

Features:

- * Full Foam Traveller grip 380 with Camera Mount System
- * Ergo strap
- * Aluminum 7075-T6, 3-sections Ø 18/16/14mm
- * Powerlock 3.0 mechanism
- * Regular UL Vario basket
- * tungsten/carbide flex tip

art. # 176 23 00-10

WALKING SINGLE STAFF



NORDIC WALKING CARBON

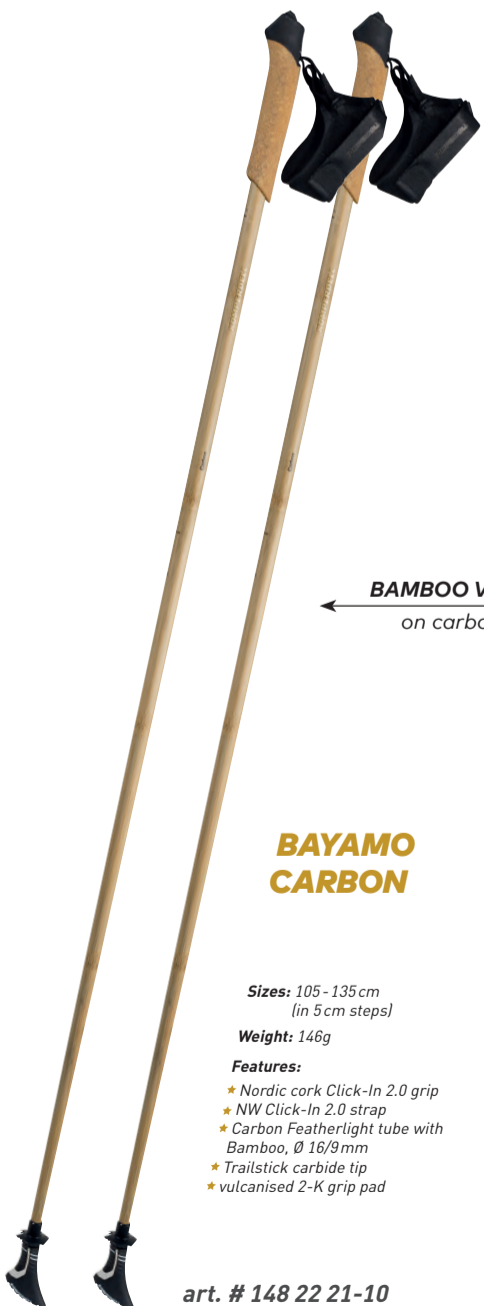

BAYAMO CARBON

Sizes: 105 - 135 cm
(in 5 cm steps)

Weight: 146g

Features:

- * Nordic cork Click-In 2.0 grip
- * NW Click-In 2.0 strap
- * Carbon Featherlight tube with Bamboo, Ø 16/9 mm
- * Trailstick carbide tip
- * vulcanised 2-K grip pad

art. # 148 22 21-10



LEVANTE CARBON

Sizes: 105 - 135 cm
(in 5 cm steps)

Weight: 132g

Features:

- * Nordic cork Click-In 2.0 grip
- * NW Click-In 2.0 strap
- * Carbon Featherlight tube, Ø 16/9 mm
- * Trailstick carbide tip
- * vulcanised 2-K grip pad

■ art. # 148 23 39-10 pure
□ art. # 148 23 39-01 pearl

← NEW CLICK-IN SYSTEM →
much easier to handle and it
locks with a distinct *Click*



PONIENTE CARBON

Sizes: 105 - 135 cm
(in 5 cm steps)

Weight: 172g

Features:

- * NW EVA UL Click-In grip
- * NW Click-In 2.0 strap
- * Carbon Composite, Ø 16/9 mm
- * Trailstick carbide tip
- * vulcanised 2-K grip pad

■ art. # 148 23 34-10 pure
□ art. # 148 23 34-01 pearl

NW PADS art. # 1029-925



art. # 1028-925

NORDIC WALKING VARIO



3 YEAR SERVICE

41cm

TRAVELLER .FXP FOLDABLE

Sizes: packed size: 41cm (115cm)
105 - 135cm
(in 10cm steps)

Weight: 111g

Features:

- * Nordic EVA UL Click-In grip
- * NW Click-In 2.0 strap
- * 3-sections: Carbon Composite, Ø 16mm
- * FXP folding mechanism
- * Trailstick carbide tip
- * vulcanised 2K grip pad

Outdoor
by SPÖ
Outstanding Outdoor
Equipment

art. # 194 23 58-10



3 YEAR SERVICE

98cm

BAYAMO CARBON VARIO

Sizes: packed size: 98cm
adjustable from 105 - 125cm

Weight: 177g

Features:

- * Nordic cork Click-In 2.0 grip
- * NW Click-In 2.0 strap
- * Carbon, 2-sections Ø 16/14mm
- * Powerlock 3.0 mechanism
- * Trailstick carbide tip
- * vulcanised 2-K grip pad

POWERLOCK 3.0
highly rigid, anodized aluminum for max. holding power!

art. # 175 22 16-10



3 YEAR SERVICE

98cm

PONIENTE CARBON VARIO

Sizes: packed size: 98cm
adjustable from 105 - 125cm

Weight: 177g

Features:

- * Nordic EVA UL Click-In grip
- * NW Click-In strap 2.0
- * Carbon, 2-sections Ø 16/14mm
- * Powerlock 3.0 mechanism
- * Trailstick carbide tip
- * vulcanised 2-K grip pad

art. # 175 23 62-10

NW PADS



art. # 1028-925



3 YEAR SERVICE

98cm

SARIMA POWERLOCK

Sizes: packed size: 98cm
adjustable from 105 - 125cm

Weight: 195g

Features:

- * Nordic EVA UL Click-In grip
- * NW Click-In strap 2.0
- * Aluminum 7075-T6, 2-sections Ø 16/14mm
- * Powerlock 3.0 mechanism
- * Trailstick carbide tip
- * vulcanised 2-K grip pad

art. # 184 23 87-10



3 YEAR SERVICE

98cm

SARIMA POWERLOCK

Sizes: packed size: 98cm
adjustable from 105 - 125cm

Weight: 195g

Features:

- * Nordic EVA UL Click-In grip
- * NW Click-In strap 2.0
- * Aluminum 7075-T6, 2-sections Ø 16/14mm
- * Powerlock 3.0 mechanism
- * Trailstick carbide tip
- * vulcanised 2-K grip pad

art. # 184 23 87-01

NW PADS



art. # 1029-925

NW PADS



art. # 1028-925



PRE-PACKED ACCESSORIES ARE ALSO AVAILABLE



VARIO SUMMER BASKET
art. # 9356-925



RACE BASKET
art. # 9352-925



RACE BASKET EXTRA SMALL
art. # 9379-925



VARIO WINTER BASKET
art. # 9364-925



VARIO WINTERBASKET XL
art. # 9912-925



VARIO DEEP POWDER BASKET
art. # 9908-925



TRAILSTICK BASKET
art. # 1022-925



TIP PROTECTOR
Ø 8mm: art. # 192-925
Ø 12mm: art. # 190-925



TIP PROTECTOR
Ø 8mm: art. # 162-925
Ø 12mm: art. # 161-925



NORDIC WALKING PADS
black/silver: art. # 1007-203
grey/silver: art. # 1007-01



NORDIC WALKING PADS
black: art. # 1028-925
light grey: art. # 1029-925



THE NEW GENERATION OF BASKETS, STRAPS AND PRE-PACKAGING!



LARGE UL ICE-FLEX BASKET
art. # 9950-925



REGULAR UL ICE-FLEX BASKET
art. # 9949-925



REGULAR UL ICE-FLEX FXP BASKET
art. # 9952-925



MINI UL BASKET
art. # 9942-925



REGULAR UL BASKET
art. # 9948-925



MINI UL VARIO BASKET
art. # 9943-925



REGULAR UL VARIO BASKET
art. # 9944-925



LARGE UL VARIO BASKET
art. # 9951-925



REGULAR UL VARIO FXP BASKET
art. # 9953-925



ERGO STRAP
black art. # 7026-925



NORDIC SPEED CLICK IN 2.0 STRAP
Sizes: S - XL
art. # 7017-925



NORDIC WALKING CLICK IN 2.0 STRAP
Sizes: XS - L
art. # 7019-925



NORDIC WALKING CLICK IN 2.0 STRAP
Sizes: XS - XL
art. # 7014-925



TRAIL CLICK IN 2.1 STRAP
Sizes: XS - XL
art. # 7018-925

EXCHANGEABLE BASKETS FOR VARIO BASKET SYSTEM



VARIO SUMMER BASKET
Ø 8,5cm art. # 9356



VARIO WINTER BASKET
Ø 8,5cm: art. # 9364



VARIO WINTER BASKET XL
Ø 10cm: art. # 9912



VARIO DEEP POWDER BASKET
Ø 13,5cm: art. # 9908



MINI UL VARIO BASKET
Ø 5 cm: art. # 9943



REGULAR UL VARIO BASKET
Ø 7cm: art. # 9944



REGULAR UL VARIO FXP BASKET
Ø 7cm: art. # 9953



LARGE UL VARIO BASKET
Ø 10,5cm: art. # 9951

BASKETS FOR STANDARD TIPS & PLUGS



RACE BASKET
Ø 6cm: art. # 9352



RACE BASKET XS
Ø 5cm: art. # 9379



DOWNHILL BASKET
art. # 9383



MINI UL BASKET
Ø 5 cm: art. # 9942



REGULAR UL BASKET
Ø 7cm: art. # 9948

BASKETS FOR ICE-FLEX SYSTEM



ICE-FLEX-SYSTEM
the simply brilliant moveable basket construction in combination with our ice-flex-tip



TUBE-COLLAR FOR ICE-FLEX SYSTEM
art. # 147



REGULAR UL ICE-FLEX BASKET
Ø 7cm: art. # 9949



REGULAR UL ICE-FLEX FXP BASKET
Ø 7cm: art. # 9952



LARGE UL ICE-FLEX BASKET
Ø 10,5cm: art. # 9950



XC SPEED BASKET
art. # 9384

STRAPS



ALPINE RACE STRAP
art. # 7304



PADDED STRAP
art. # 7342



SYSTEM STRAP
art. # 7307

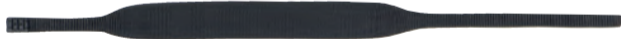

SYSTEM STRAP XL
art. # 7308



LEATHER STRAP
with embossed logo: art. # 7313-2K



JUNIOR STRAP
art. # 7303



STANDARD STRAP
art. # 7301



WALKER PADDED STRAP
art. # 7305

POWDER / POWDER PADDED STRAP

Powder art. # 7350
Powder Padded: art. # 7023



CLICK-IN 2.1 ERGO STRAP WITH
art. # 7026-2K-40



New Strap System

COMFORT / COMFORT PADDED STRAP

Comfort: art. # 7021
Comfort Padded: art. # 7022



NORDIC & NORDIC WALKING STRAPS



NORDIC SPEED CLICK-IN 2.0 STRAP
available in following sizes:
S - M - L
art. # 7017



NORDIC WALKING CLICK-IN 2.0 STRAP
available in following sizes:
XS - S - M - L
art. # 7014



TRAIL CLICK-IN 2.1 STRAP
available in following sizes:
XS - S - M - L
art. # 7018



NORDIC PADDED STRAP
art. # 7310



NORDIC CLASSIC STRAP
art. # 7331

FLEX TIPS FOR VARIO BASKET SYSTEMS



**ICE-FLEX
TUNGSTEN/CARBIDE
TIP**

Ø 9mm, standard version:
art. # 145



**VARIO TUNGSTEN/
CARBIDE FLEX TIP**

Ø 9mm: art. # 178
for POWERLOCK:
Ø 9mm: art. # 99



**VARIO TUNGSTEN/
CARBIDE FLEX
TIP SHORT**

Ø 9mm: art. # 193
for POWERLOCK:
Ø 9mm: art. # 174



**NORDIC VARIO
TUNGSTEN/
CARBIDE TIP**

Ø 9mm: art. # 1015



VARIO PLUG
art. # 108

FLEX TIPS FOR STANDARD BASKETS



**TUNGSTEN/CARBIDE
FLEX TIP
SHORT**

Ø 9mm: art. # 160



**TUNGSTEN/
CARBIDE FLEX
TIP SHORT**

Ø 9mm: art. # 96



**BASKET
FIXING
PLUG**

art. # 101



TUBE COLLAR
art. # 100

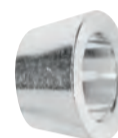

ALLOY PLUG
art. # 106

NORDIC WALKING, TRAIL & WALKER TIPS



TRAILSTICK TIP

with tungsten/carbide hollow tip:
Ø 9mm: art. # 1022



TIP PROTECTOR

Ø 8mm: art. # 192
Ø 12mm: art. # 190



**NORDIC WALKING
CLASSIC COLOR PAD**

Ø 12mm black: art. # 1007-203



**NORDIC/BC
TOURING BASKET**

with steel tip:
art. # 9375



**NORDIC TREK
ULTRALIGHT BASKET**

holebasket
with tungsten/carbide tip:
Ø 9mm: art. # 9941



**NORDIC TRAIL
ULTRALIGHT TELLER**

with tungsten/carbide tip:
Ø 9mm: art. # 9938



**XC
TELLER**

with steel tip:
art. # 9361

ADJUSTING MECHANISM



POWERLOCK 3.0

18/16mm: art. # 1291
16/14mm: art. # 1292



POWERLOCK 2.1

18/16mm: art. # 1280
16/14mm: art. # 1282



**TUBE
COLLAR**

Ø 16mm: art. # 1302
Ø 18mm: art. # 1301



THREADED PART

Ø 14mm: art. # 1209
Ø 16mm: art. # 1207



EXPANDING NUT

Ø 14mm: art. # 1210
Ø 16mm: art. # 1208



**THREADED PART
TITANAL.HF**

Ø 14mm: art. # 1272
Ø 16mm: art. # 1274



**EXPANDING NUT
TITANAL.HF**

Ø 14mm: art. # 1273
Ø 16mm: art. # 1275

ALPINE, TOURING & TREKKING GRIPS



LEATHER GRIP CLASSIC
Ø 16mm: art. # 8854



RACE DUPLO GRIP
Ø 12,3mm: art. # 8073
Ø 13mm: art. # 8079
Ø 16mm: art. # 8549



LIGHTNING DUPLO GRIP
Ø 13mm: art. # 8047
art. # 8038



LIGHTNING TOUR DUPLO GRIP
Ø 13mm: art. # 8101



FOAM EXPEDITION SHORT GRIP
Ø 18mm: art. # 8010-02
Ø 20mm: art. # 8166-02



FOAM ALPINE GRIP
Ø 18mm: art. # 8784



TOURING GRIP
PE, race Ø 18mm: art. # 8321
TOURING GRIP SYSTEM
rubber, race Ø 18mm: art. # 8179
rubber, race Ø 13mm: art. # 8183
PU, race Ø 18mm: art. # 8180
RACE GRIP RUBBER LIME-GREEN
Ø 16mm: art. # 8264
Ø 18mm: art. # 8818
Ø 19mm: art. # 8233



COMPACT GRIP SYSTEM
PU, Ø 13mm: art. # 8214
PU, Ø 18mm: art. # 8239
PU, Ø 19mm: art. # 8256
PE, Ø 18mm: art. # 8241
rubber, Ø 18mm: art. # 8238
Cork, Ø 18mm: art. # 8239-255



COMPACT GRIP STANDARD
PE:
Ø 18mm: art. # 8728



WALKER COMFORT GRIP
Cork:
Ø 16mm: art. # 8773-255
Ø 18mm: art. # 8764-255



SABRE GRIP KIDS
Ø 14mm: art. # 8082
Ø 16mm: art. # 8042



JUNIOR JET GRIP
Ø 13mm: art. # 8220
Ø 14mm: art. # 8234
Ø 16mm: art. # 8236



JUNIOR GRIP
PE:
Ø 14mm: art. # 8206
PU:
Ø 16mm: art. # 8734



KIDS RACE GRIP
PE:
Ø 14mm: art. # 8182
Ø 16mm: art. # 8181
PU:
Ø 16mm: art. # 8320



TREK 170 GRIP
PE - Ø 16mm: art. # 8165
Cork - Ø 18mm: art. # 8130-255
Rubber - Ø 18mm: art. # 8130-02



FOAM 280 GRIP
Ø 16mm: art. # 8159
Ø 18mm: art. # 8135



PISTOL 2K GRIP
Ø 13mm: art. # 8317
Ø 16mm: art. # 8318
Ø 18mm: art. # 8319



2K TOURING FOAM 280 GRIP
Ø 16mm: art. # 8306-202A black-orange
art. # 8306-212B black-silver
Ø 18mm: art. # 8307-212B black-silver



2K TOURING FOAM 450 GRIP
Ø 16mm: art. # 8308-202A



FOAM PISTOL 120 GRIP
Ø 13mm: art. # 8313
Ø 16mm: art. # 8314

TOURING, NORDIC & NORDIC WALKING GRIPS



TOURING 2K CLICK-IN 2.0 GRIP
Ø 18mm: art. # 8902-202



NORDIC 2K CLICK-IN 2.0 GRIP
Ø 16mm: art. # 8184



NORDIC 2K CLICK-IN 2.0 GRIP
Ø 16mm, FOAM: art. # 8177



XC GRIP
without CLICK-IN
FOAM:
Ø 16mm: art. # 8721
Ø 18mm: art. # 8738



XC CLASSIC GRIP
PE:
Ø 16mm: art. # 8004-02
Cork:
Ø 16mm: art. # 8004-225

putz
DRUCKTECHNIK



PROTECTION DEMO-SET

Features:
 * Set of various protector demo inserts

art. # 6649-10



DEMO BALLISTIC VEST ON TORSO

Features:
 * technique of the Ballistic Vest
 * consists of torso, Ballistic Vest and Pro Short

art. # 6254-206



PROTECTION SKI CROSS FLEX DEMO BOARD

Features:
 * 60 x 78 cm
 * Kapa material 5 mm
 * removable protector insert
 * with optional hook to fix on cloth rail

art. # 6255-202



DISPLAY MANNEQUINS & TORSI

Males mannequin: art. # 2080-99
 Ladies mannequin: art. # 2081-99
 Junior mannequin: art. # 2082-99
 Male torso: art. # 2083-99
 Female torso: art. # 2084-99



MONITOR DISPLAY SMALL 10 INCH

Space-saving display for corporate and product videos for a holistic and customer-friendly product presentation.

Size 24,5 x 16,9 CM
 Resolution 1920 x 1080

art. # 6579-10

MONITOR DISPLAY BIG 15 INCH

Elegant display for company and product videos for a holistic and customer-friendly product presentation.

Size 34,1 x 27,3 cm
 Resolution 1024x768

art. # 6580-10



IMPACT TEST MACHINE GONDOLA SINGLE

Features:
 * 1735x1700x625mm
 * power and individual air connection will be needed (oxygen tank possible)
 * incl. clothes rail for protectors

art. # 6544-10



TEAM VEST MEN

Sizes: XS-L
 * innovative material-mix: extra-light light shell material combined with smart breathable thermo-padding
 * removeable hood stormproof

art. # 6344-02



TEAM VEST WOMEN

Sizes: XS-L
 * innovative material-mix: extra-light light shell material combined with smart breathable thermo-padding
 * removeable hood stormproof

art. # 6345-02



CLOUD DISPLAY

- Features:**
- ★ Size: 36x180cm
 - ★ to hang up or to line up
 - ★ Instore Display for pole series "CLOUD" with digital scale

art. # 56-99



BLACK LIGHT PRESENTATION FOR NATIONALTEAM POLES

- Features:**
- ★ 60W
 - ★ 1,5m cable length
 - ★ easy assembly
 - ★ consisting of lamp, mount, plug and remote
 - ★ appropriate for shop window, order fair, showrooms, highlight/product presentation

art. # 6456-10



DISPLAY HENRIK KRISTOFFERSEN

- Features:**
- ★ life-sized shop display
 - ★ 190 cm height
 - ★ real poles can be fixed on the display
 - ★ poles not included in the price

art. # 54-999

KOMPERDELL
www.komperdell.com

KOMPERDELL
www.komperdell.com

LOGO BANNER

- Features:**
- ★ 200x70 cm
 - ★ fully eyed and seamed
 - ★ perfect for promotion to hang into shop windows, in the window, on fences etc.

art. # 35-48 art. # 35-29



BEACHFLAGS

- Features:**
- ★ padded transportation bag
 - ★ base plate 18x30x0,6 cm for indoor use or bolt for outdoor use

total height 250cm total height 450cm
art. # 34-48 art. # 29-48
art. # 34-29 art. # 29-29

KOMPERDELL

KOMPERDELL



WOODEN POLE DISPLAY

- Features:**
- ★ for 16 pairs of poles (without poles)

art. # 181-25

- ★ for 8 pairs of poles (without poles)

art. # 431-25



LOT BOX

- Features:**
- ★ 59x86x36 cm (with drawer 84x86x36cm, measured without poles)
 - ★ Instore display for 25 pairs of telescopic or fixed length poles
 - ★ made of cardboard
 - ★ 4 drawers included for accessories
 - ★ perfect for every shop

art. # 57-999

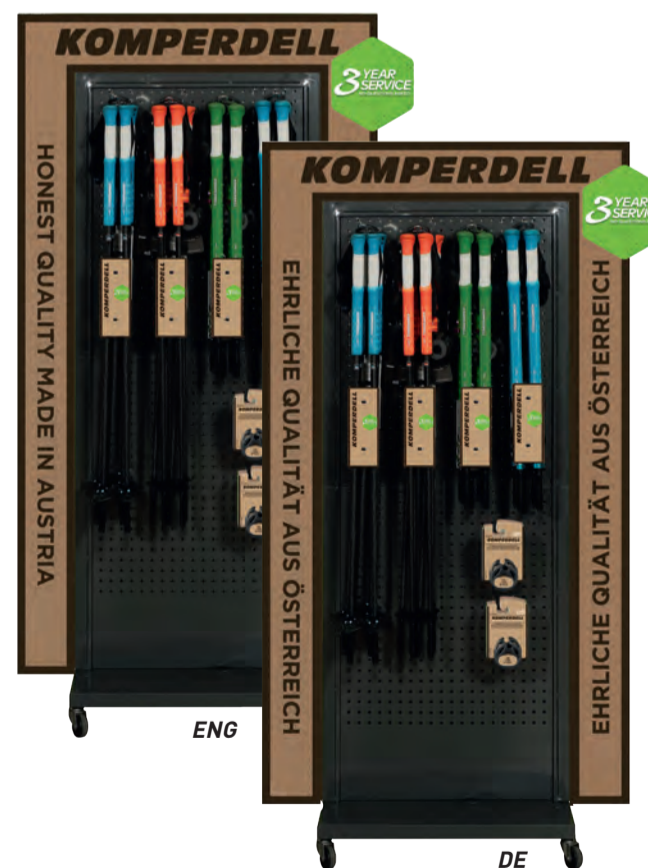

POLE DISPLAY

- Features:**
- ★ Instore display for Trekking- and Alpine poles
 - ★ made of strong aluminum
 - ★ with wheels
 - ★ perfect for any shop
 - ★ includes 12 hooks

art. # 56-999



POLE PACKAGING

Ø 16mm: art. # 2328-16
Ø 18mm: art. # 2328-18



HEADQUARTERS MONDSEE

KOMPERDELL GmbH

Wagnermühle 30

5310 Mondsee • Austria

phone: +43/6232/4201-0

e-mail: sales@komperdell.com

www.komperdell.com

DISTRIBUTION NORTH AMERICA

CAMARO USA, LLC

1021, 39th Avenue SE

Puyallup, WA 98374 • USA

phone: +1 253-867-57 35

e-mail: sales-usa@camaro.at

www.komperdell.com

KOMPERDELL
www.komperdell.com



[komperdell.outdoor.sport](https://www.facebook.com/komperdell.outdoor.sport)



[komperdell_official](https://www.instagram.com/komperdell_official)



[Komperdell](https://www.youtube.com/Komperdell)